

TOSHIBA

FILE NO. A10-2006

SERVICE MANUAL

AIR-CONDITIONER MULTI TYPE

INDOOR UNIT

< Slim duct type >

MMD-UP0031SPHY-E

MMD-UP0051SPHY-E

MMD-UP0071SPHY-E

MMD-UP0091SPHY-E

MMD-UP0121SPHY-E

MMD-UP0151SPHY-E

MMD-UP0181SPHY-E

MMD-UP0241SPHY-E

MMD-UP0271SPHY-E

MMD-UP0031SPHY-TR

MMD-UP0051SPHY-TR

MMD-UP0071SPHY-TR

MMD-UP0091SPHY-TR

MMD-UP0121SPHY-TR

MMD-UP0151SPHY-TR

MMD-UP0181SPHY-TR

MMD-UP0241SPHY-TR

MMD-UP0271SPHY-TR

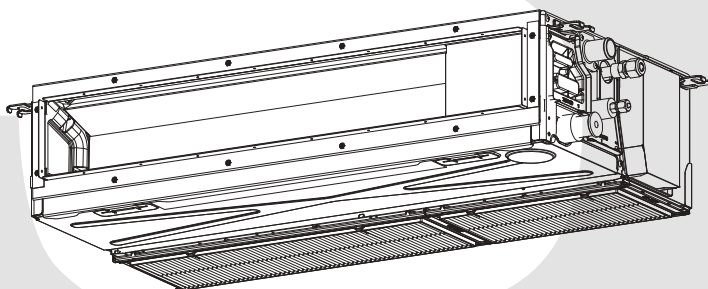

CONTENTS

PRECAUTIONS FOR SAFETY.....	6
1. SPECIFICATIONS	11
2. FAN CHARACTERISTICS.....	13
3. CONSTRUCTION VIEWS (EXTERNAL VIEWS).....	15
4. WIRING DIAGRAMS.....	16
5. PARTS RATING.....	17
6. REFRIGERATION CYCLE DIAGRAM	18
7. CONTROL OUTLINE	19
7-1. Control Specifications	19
8. COMMUNICATION TYPE, MODEL NAMES AND THE MAXIMUM NUMBER OF CONNECTABLE UNITS	29
9. APPLIED CONTROL AND FUNCTIONS	30
9-1. Indoor Controller Block Diagram.....	30
9-2. Indoor P.C. board	33
9-3. Functions at test run.....	35
9-4. Setup of Selecting Function in Indoor Unit	38
9-5. Applied Control in Indoor Unit.....	42
10. TROUBLESHOOTING	54
10-1. Overview	54
10-2. Troubleshooting method.....	55
10-3. Troubleshooting based on information displayed on remote controller.....	61
10-4. Check Codes Displayed on Remote Controller and SMMS series Outdoor Unit	66
10-5. Diagnostic Procedure for Each Check Code (Indoor Unit)	81
10-6. Sensor characteristics.....	89
11. REPLACEMENT OF SERVICE P.C. BOARD	91
12. DETACHMENTS	97
13. EXPLODED VIEWS AND PARTS LIST	107

Please read carefully through these instructions that contain important information which complies with the Machinery Directive (Directive 2006/42/EC), and ensure that you understand them.

Generic Denomination: Air Conditioner

Definition of Qualified Installer or Qualified Service Person

The air conditioner must be installed, maintained, repaired and removed by a qualified installer or qualified service person. When any of these jobs is to be done, ask a qualified installer or qualified service person to do them.

A qualified installer or qualified service person is an agent who has the qualifications and knowledge described in the table below.

Agent	Qualifications and knowledge which the agent must have
Qualified installer (*1)	<ul style="list-style-type: none"> • The qualified installer is a person who installs, maintains, relocates and removes the air conditioners made by Toshiba Carrier Corporation. He or she has been trained to install, maintain, relocate and remove the air conditioners made by Toshiba Carrier Corporation or, alternatively, he or she has been instructed in such operations by an individual or individuals who have been trained and is thus thoroughly acquainted with the knowledge related to these operations. • The qualified installer who is allowed to do the electrical work involved in installation, relocation and removal has the qualifications pertaining to this electrical work as stipulated by the local laws and regulations, and he or she is a person who has been trained in matters relating to electrical work on the air conditioners made by Toshiba Carrier Corporation or, alternatively, he or she has been instructed in such matters by an individual or individuals who have been trained and is thus thoroughly acquainted with the knowledge related to this work. • The qualified installer who is allowed to do the refrigerant handling and piping work involved in installation, relocation and removal has the qualifications pertaining to this refrigerant handling and piping work as stipulated by the local laws and regulations, and he or she is a person who has been trained in matters relating to refrigerant handling and piping work on the air conditioners made by Toshiba Carrier Corporation or, alternatively, he or she has been instructed in such matters by an individual or individuals who have been trained and is thus thoroughly acquainted with the knowledge related to this work. • The qualified installer who is allowed to work at heights has been trained in matters relating to working at heights with the air conditioners made by Toshiba Carrier Corporation or, alternatively, he or she has been instructed in such matters by an individual or individuals who have been trained and is thus thoroughly acquainted with the knowledge related to this work.
Qualified service person (*1)	<ul style="list-style-type: none"> • The qualified service person is a person who installs, repairs, maintains, relocates and removes the air conditioners made by Toshiba Carrier Corporation. He or she has been trained to install, repair, maintain, relocate and remove the air conditioners made by Toshiba Carrier Corporation or, alternatively, he or she has been instructed in such operations by an individual or individuals who have been trained and is thus thoroughly acquainted with the knowledge related to these operations. • The qualified service person who is allowed to do the electrical work involved in installation, repair, relocation and removal has the qualifications pertaining to this electrical work as stipulated by the local laws and regulations, and he or she is a person who has been trained in matters relating to electrical work on the air conditioners made by Toshiba Carrier Corporation or, alternatively, he or she has been instructed in such matters by an individual or individuals who have been trained and is thus thoroughly acquainted with the knowledge related to this work. • The qualified service person who is allowed to do the refrigerant handling and piping work involved in installation, repair, relocation and removal has the qualifications pertaining to this refrigerant handling and piping work as stipulated by the local laws and regulations, and he or she is a person who has been trained in matters relating to refrigerant handling and piping work on the air conditioners made by Toshiba Carrier Corporation or, alternatively, he or she has been instructed in such matters by an individual or individuals who have been trained and is thus thoroughly acquainted with the knowledge related to this work. • The qualified service person who is allowed to work at heights has been trained in matters relating to working at heights with the air conditioners made by Toshiba Carrier Corporation or, alternatively, he or she has been instructed in such matters by an individual or individuals who have been trained and is thus thoroughly acquainted with the knowledge related to this work.

Definition of Protective Gear

When the air conditioner is to be transported, installed, maintained, repaired or removed, wear protective gloves and 'safety' work clothing.

In addition to such normal protective gear, wear the protective gear described below when undertaking the special work detailed in the table below.



Failure to wear the proper protective gear is dangerous because you will be more susceptible to injury, burns, electric shocks and other injuries.

Work undertaken	Protective gear worn
All types of work	Protective gloves 'Safety' working clothing
Electrical-related work	Gloves to provide protection for electricians Insulating shoes Clothing to provide protection from electric shock
Work done at heights (50 cm or more)	Helmets for use in industry
Transportation of heavy objects	Shoes with additional protective toe cap
Repair of outdoor unit	Gloves to provide protection for electricians

The important contents concerned to the safety are described on the product itself and on this Service Manual.



Please read this Service Manual after understanding the described items thoroughly in the following contents (Indications / Illustrated marks), and keep them.

[Explanation of indications]

Indication	Explanation
 DANGER	Indicates contents assumed that an imminent danger causing a death or serious injury of the repair engineers and the third parties when an incorrect work has been executed.
 WARNING	Indicates possibilities assumed that a danger causing a death or serious injury of the repair engineers, the third parties, and the users due to troubles of the product after work when an incorrect work has been executed.
 CAUTION	Indicates contents assumed that an injury or property damage (*) may be caused on the repair engineers, the third parties, and the users due to troubles of the product after work when an incorrect work has been executed.

* Property damage: Enlarged damage concerned to property, furniture, and domestic animal / pet





[Explanation of illustrated marks]

Indication	Explanation
	Indicates prohibited items (Forbidden items to do) The sentences near an illustrated mark describe the concrete prohibited contents.
	Indicates mandatory items (Compulsory items to do) The sentences near an illustrated mark describe the concrete mandatory contents.
	Indicates cautions (Including danger / warning) The sentences or illustration near or in an illustrated mark describe the concrete cautious contents.

Warning Indications on the Air Conditioner Unit

[Confirmation of warning label on the main unit]





Confirm that labels are indicated on the specified positions
 If removing the label during parts replace, stick it as the original.

Warning indication	Description				
 <table border="1" data-bbox="304 409 659 633"> <tr> <td colspan="2" style="text-align: center;">WARNING</td> </tr> <tr> <td colspan="2">ELECTRICAL SHOCK HAZARD Disconnect all remote electric power supplies before servicing.</td> </tr> </table>	WARNING		ELECTRICAL SHOCK HAZARD Disconnect all remote electric power supplies before servicing.		<p>WARNING</p> <p>ELECTRICAL SHOCK HAZARD Disconnect all remote electric power supplies before servicing.</p>
WARNING					
ELECTRICAL SHOCK HAZARD Disconnect all remote electric power supplies before servicing.					
 <table border="1" data-bbox="304 689 659 913"> <tr> <td colspan="2" style="text-align: center;">WARNING</td> </tr> <tr> <td colspan="2">Moving parts. Do not operate unit with grille removed. Stop the unit before the servicing.</td> </tr> </table>	WARNING		Moving parts. Do not operate unit with grille removed. Stop the unit before the servicing.		<p>WARNING</p> <p>Moving parts. Do not operate unit with grille removed. Stop the unit before the servicing.</p>
WARNING					
Moving parts. Do not operate unit with grille removed. Stop the unit before the servicing.					
 <table border="1" data-bbox="304 969 659 1193"> <tr> <td colspan="2" style="text-align: center;">CAUTION</td> </tr> <tr> <td colspan="2">High temperature parts. You might get burned when removing this panel.</td> </tr> </table>	CAUTION		High temperature parts. You might get burned when removing this panel.		<p>CAUTION</p> <p>High temperature parts. You might get burned when removing this panel.</p>
CAUTION					
High temperature parts. You might get burned when removing this panel.					
 <table border="1" data-bbox="304 1249 659 1473"> <tr> <td colspan="2" style="text-align: center;">CAUTION</td> </tr> <tr> <td colspan="2">Do not touch the aluminum fins of the unit. Doing so may result in injury.</td> </tr> </table>	CAUTION		Do not touch the aluminum fins of the unit. Doing so may result in injury.		<p>CAUTION</p> <p>Do not touch the aluminium fins of the unit. Doing so may result in injury.</p>
CAUTION					
Do not touch the aluminum fins of the unit. Doing so may result in injury.					
 <table border="1" data-bbox="304 1529 659 1753"> <tr> <td colspan="2" style="text-align: center;">CAUTION</td> </tr> <tr> <td colspan="2">BURST HAZARD Open the service valves before the operation, otherwise there might be the burst.</td> </tr> </table>	CAUTION		BURST HAZARD Open the service valves before the operation, otherwise there might be the burst.		<p>CAUTION</p> <p>BURST HAZARD Open the service valves before the operation, otherwise there might be the burst.</p>
CAUTION					
BURST HAZARD Open the service valves before the operation, otherwise there might be the burst.					

PRECAUTIONS FOR SAFETY



The manufacturer shall not assume any liability for the damage caused by not observing the description of this manual.

DANGER







 Turn off braeaker	<p>Before carrying out the installation, maintenance, repair or removal work, be sure to set the circuit breaker for both the indoor and outdoor units to the OFF position. Otherwise, electric shocks may result.</p>
	<p>Before opening the electrical box cover of the indoor unit or service panel of the outdoor unit, set the circuit breaker to the OFF position. Failure to set the circuit breaker to the OFF position may result in electric shocks through contact with the interior parts. Only a qualified installer (*1) or qualified service person (*1) is allowed to remove the intake grille of the indoor unit or service panel of the outdoor unit and do the work required.</p>
	<p>Before opening the suction board cover, set the circuit breaker to the OFF position. Failure to set the circuit breaker to the OFF position may result in injury through contact with the rotation parts. Only a qualified installer (*1) or qualified service person (*1) is allowed to remove the suction board cover and do the work required.</p>
	<p>Before starting to repair the outdoor unit fan or fan guard, be absolutely sure to set the circuit breaker to the OFF position, and place a "Work in progress" sign on the circuit breaker.</p>
	<p>When cleaning the filter or other parts of the indoor unit, set the circuit breaker to OFF without fail, and place a "Work in progress" sign near the circuit breaker before proceeding with the work.</p>
	<p>When you have noticed that some kind of trouble (such as when a check code display has appeared, there is a smell of burning, abnormal sounds are heard, the air conditioner fails to cool or heat or water is leaking) has occurred in the air conditioner, do not touch the air conditioner yourself but set the circuit breaker to the OFF position, and contact a qualified service person. Take steps to ensure that the power will not be turned on (by marking "out of service" near the circuit breaker, for instance) until qualified service person arrives. Continuing to use the air conditioner in the trouble status may cause mechanical problems to escalate or result in electric shocks or other failure.</p>
 Electric shock hazard	<p>When you access inside of the service panel to repair electric parts, wait for about five minutes after turning off the breaker. Do not start repairing immediately. Otherwise you may get electric shock by touching terminals of high-voltage capacitors. Natural discharge of the capacitor takes about five minutes.</p>
	<p>When checking the electric parts, removing the cover of the electric parts box of Indoor Unit and/or service panel of Outdoor Unit inevitably to determine the failure, use gloves to provide protection for electricians, insulating shoes, clothing to provide protection from electric shock and insulating tools. Be careful not to touch the live part. Electric shock may result. Only "Qualified service person" is allowed to do this work.</p>
 Prohibition	<p>Place a "Work in progress" sign near the circuit breaker while the installation, maintenance, repair or removal work is being carried out. There is a danger of electric shocks if the circuit breaker is set to ON by mistake.</p>
	<p>When checking the electric parts, removing the cover of the electric parts box of Indoor Unit and/or front panel of outdoor unit inevitably to determine the failure, put a sign "Do not enter" around the site before the work. Failure to do this may result in third person getting electric shock.</p>
	<p>Before operating the air conditioner after having completed the work, check that the electrical parts box cover of the indoor unit and service panel of the outdoor unit are closed, and set the circuit breaker to the ON position. You may receive an electric shock if the power is turned on without first conducting these checks.</p>
 Stay on protection	<p>If, in the course of carrying out repairs, it becomes absolutely necessary to check out the electrical parts with the electrical parts box cover of one or more of the indoor units and the service panel of the outdoor unit removed in order to find out exactly where the trouble lies, wear insulated heat-resistant gloves, insulated boots and insulated work overalls, and take care to avoid touching any live parts. You may receive an electric shock if you fail to heed this warning. Only qualified service person (*1) is allowed to do this kind of work.</p>







(*1) Refer to the "Definition of Qualified Installer or Qualified Service Person"

 **WARNIG**



 General	<p>Before starting to repair the air conditioner, read carefully through the Service Manual, and repair the air conditioner by following its instructions.</p>
	<p>Only qualified service person (*1) is allowed to repair the air conditioner. Repair of the air conditioner by unqualified person may give rise to a fire, electric shocks, injury, water leaks and / or other problems.</p>
	<p>Do not use any refrigerant different from the one specified for complement or replacement. Otherwise, abnormally high pressure may be generated in the refrigeration cycle, which may result in a failure or explosion of the product or an injury to your body.</p>
	<p>Only a qualified installer (*1) or qualified service person (*1) is allowed to carry out the electrical work of the air conditioner. Under no circumstances must this work be done by an unqualified individual since failure to carry out the work properly may result in electric shocks and / or electrical leaks.</p>
	<p>When the air conditioner is to be transported, installed, maintained, repaired or removed, wear protective gloves and 'safety' work clothing.</p>
	<p>To connect the electrical wires, repair the electrical parts or undertake other electrical jobs, wear gloves to provide protection for electricians, insulating shoes and clothing to provide protection from electric shocks. Failure to wear this protective gear may result in electric shocks.</p>
	<p>Electrical wiring work shall be conducted according to law and regulation in the community and installation manual. Failure to do so may result in electrocution or short circuit.</p>
	<p>Use wiring that meets the specifications in the Installation Manual and the stipulations in the local regulations and laws. Use of wiring which does not meet the specifications may give rise to electric shocks, electrical leakage, smoking and/or a fire.</p>
	<p>Only a qualified installer (*1) or qualified service person (*1) is allowed to undertake work at heights using a stand of 50 cm or more or to remove the intake grille of the indoor unit to undertake work.</p>
	<p>When working at heights, use a ladder which complies with the ISO 14122 standard, and follow the procedure in the ladder's instructions. Also wear a helmet for use in industry as protective gear to undertake the work.</p>
	<p>Before working at heights, put a sign in place so that no-one will approach the work location, before proceeding with the work. Parts and other objects may fall from above, possibly injuring a person below. While carrying out the work, wear a helmet for protection from falling objects.</p>
	<p>When executing address setting, test run, or troubleshooting through the checking window on the electric parts box, put on insulated gloves to provide protection from electric shock. Otherwise you may receive an electric shock.</p>
	<p>Do not touch the aluminum fin of the outdoor unit. You may injure yourself if you do so. If the fin must be touched for some reason, first put on protective gloves and safety work clothing, and then proceed.</p>
	<p>Do not climb onto or place objects on top of the outdoor unit. You may fall or the objects may fall off of the outdoor unit and result in injury.</p>
	<p>Use forklift to carry in the air conditioner units and use winch or hoist at installation of them.</p>
	<p>When transporting the air conditioner, wear shoes with protective toe caps, protective gloves and other protective clothing.</p>
	<p>When transporting the air conditioner, do not take hold of the bands around the packing carton. You may injure yourself if the bands should break.</p>
<p>Be sure that a heavy unit (10 kg or heavier) such as a compressor is carried by two persons.</p>	
 Check earth wires.	<p>Before troubleshooting or repair work, check the earth wire is connected to the earth terminals of the main unit, otherwise an electric shock is caused when a leak occurs. If the earth wire is not correctly connected, contact an electric engineer for rework.</p>
	<p>After completing the repair or relocation work, check that the ground wires are connected properly.</p>
	<p>Be sure to connect earth wire. (Grounding work) Incomplete grounding causes an electric shock. Do not connect ground wires to gas pipes, water pipes, and lightning rods or ground wires for telephone wires.</p>

(*1) Refer to the "Definition of Qualified Installer or Qualified Service Person"

 Prohibition of modification.	<p>Do not modify the products. Do not also disassemble or modify the parts. It may cause a fire, electric shock or injury.</p>
 Use specified parts.	<p>When any of the electrical parts are to be replaced, ensure that the replacement parts satisfy the specifications given in the Service Manual (or use the parts contained on the parts list in the Service Manual). Use of any parts which do not satisfy the required specifications may give rise to electric shocks, smoking and / or a fire.</p>
 Do not bring a child close to the equipment.	<p>If, in the course of carrying out repairs, it becomes absolutely necessary to check out the electrical parts with the electrical parts box cover of one or more of the indoor units and the service panel of the outdoor unit removed in order to find out exactly where the trouble lies, put a sign in place so that no-one will approach the work location before proceeding with the work. Third-party individuals may enter the work site and receive electric shocks if this warning is not heeded.</p>
 Insulating measures	<p>Connect the cut-off lead wires with crimp contact, etc., put the closed end side upward and then apply a watercut method, otherwise a leak or production of fire is caused at the users' side.</p>
 No fire	<p>When performing repairs using a gas burner, replace the refrigerant with nitrogen gas because the oil that coats the pipes may otherwise burn. When repairing the refrigerating cycle, take the following measures.</p> <ol style="list-style-type: none"> 1) Be attentive to fire around the cycle. When using a gas stove, etc., be sure to put out fire before work; otherwise the oil mixed with refrigerant gas may catch fire. 2) Do not use a welder in the closed room. When using it without ventilation, carbon monoxide poisoning may be caused. 3) Do not bring inflammables close to the refrigerant cycle, otherwise fire of the welder may catch the inflammables.
 Refrigerant	<p>The refrigerant used by this air conditioner is the R410A.</p> <p>Check the used refrigerant name and use tools and materials of the parts which match with it. For the products which use R410A refrigerant, the refrigerant name is indicated at a position on the outdoor unit where is easy to see. To prevent miss-charging, the route of the service port is changed from one of the former R22.</p> <p>Do not use any refrigerant different from the one specified for complement or replacement. Otherwise, abnormally high pressure may be generated in the refrigeration cycle, which may result in a failure or explosion of the product or an injury to your body.</p> <p>For an air conditioner which uses R410A, never use other refrigerant than R410A. For an air conditioner which uses other refrigerant (R22, etc.), never use R410A. If different types of refrigerant are mixed, abnormal high pressure generates in the refrigerating cycle and an injury due to breakage may be caused.</p> <p>When the air conditioner has been installed or relocated, follow the instructions in the Installation Manual and purge the air completely so that no gases other than the refrigerant will be mixed in the refrigerating cycle. Failure to purge the air completely may cause the air conditioner to malfunction.</p> <p>Do not charge refrigerant additionally. If charging refrigerant additionally when refrigerant gas leaks, the refrigerant composition in the refrigerating cycle changes resulted in change of air conditioner characteristics or refrigerant over the specified standard amount is charged and an abnormal high pressure is applied to the inside of the refrigerating cycle resulted in cause of breakage or injury. Therefore if the refrigerant gas leaks, recover the refrigerant in the air conditioner, execute vacuuming, and then newly recharge the specified amount of liquid refrigerant. In this time, never charge the refrigerant over the specified amount.</p> <p>When recharging the refrigerant in the refrigerating cycle, do not mix the refrigerant or air other than R410A into the specified refrigerant. If air or others is mixed with the refrigerant, abnormal high pressure generates in the refrigerating cycle resulted in cause of injury due to breakage.</p> <p>After installation work, check the refrigerant gas does not leak. If the refrigerant gas leaks in the room, poisonous gas generates when gas touches to fire such as fan heater, stove or cooking stove though the refrigerant gas itself is innocuous.</p> <p>Never recover the refrigerant into the outdoor unit. When the equipment is moved or repaired, be sure to recover the refrigerant with recovering device. The refrigerant cannot be recovered in the outdoor unit; otherwise a serious accident such as breakage or injury is caused.</p>

 Assembly / Wiring	After repair work, surely assemble the disassembled parts, and connect and lead the removed wires as before. Perform the work so that the cabinet or panel does not catch the inner wires. If incorrect assembly or incorrect wire connection was done, a disaster such as a leak or fire is caused at user's side.
 Insulator check	After the work has finished, be sure to use an insulation tester set (500 V Megger) to check the resistance is 1 MΩ or more between the charge section and the non-charge metal section (Earth position). If the resistance value is low, a disaster such as a leak or electric shock is caused at user's side.
 Ventilation	When the refrigerant gas leaks during work, execute ventilation. If the refrigerant gas touches to a fire, poisonous gas generates. A case of leakage of the refrigerant and the closed room full with gas is dangerous because a shortage of oxygen occurs. Be sure to execute ventilation. If refrigerant gas has leaked during the installation work, ventilate the room immediately. If the leaked refrigerant gas comes in contact with fire, noxious gas may generate. After installation work, check the refrigerant gas does not leak. If the refrigerant gas leaks in the room, poisonous gas generates when gas touches to fire such as fan heater, stove or cooking stove though the refrigerant gas itself is innocuous.
 Compulsion	When the refrigerant gas leaks, find up the leaked position and repair it surely. If the leaked position cannot be found up and the repair work is interrupted, reclaim and tighten the service valve, otherwise the refrigerant gas may leak into the room. The poisonous gas generates when gas touches to fire such as fan heater, stove or cooking stove though the refrigerant gas itself is innocuous. When installing equipment which includes a large amount of charged refrigerant such as a multi air conditioner in a sub-room, it is necessary that the density does not the limit even if the refrigerant leaks. If the refrigerant leaks and exceeds the limit density, an accident of shortage of oxygen is caused. Tighten the flare nut with a torque wrench in the specified manner. Excessive tighten of the flare nut may cause a crack in the flare nut after a long period, which may result in refrigerant leakage. Nitrogen gas must be used for the airtight test. The charge hose must be connected in such a way that it is not slack. For the installation / moving / reinstallation work, follow to the Installation Manual. If an incorrect installation is done, a trouble of the refrigerating cycle, water leak, electric shock or fire is caused.
 Check after repair	Once the repair work has been completed, check for refrigerant leaks, and check the insulation resistance and water drainage. Then perform a trial run to check that the air conditioner is running properly. After repair work has finished, check there is no trouble. If check is not executed, a fire, electric shock or injury may be caused. For a check, turn off the power breaker. After repair work (installation of front panel and cabinet) has finished, execute a test run to check there is no generation of smoke or abnormal sound. If check is not executed, a fire or an electric shock is caused. Before test run, install the front panel and cabinet. Be sure to fix the screws back which have been removed for installation or other purposes.
 Do not operate the unit with the valve closed.	Check the following matters before a test run after repairing piping. <ul style="list-style-type: none"> • Connect the pipes surely and there is no leak of refrigerant. • The valve is opened. Running the compressor under condition that the valve closes causes an abnormal high pressure resulted in damage of the parts of the compressor and etc. and moreover if there is leak of refrigerant at connecting section of pipes, the air is sucked and causes further abnormal high pressure resulted in burst or injury.
 Check after reinstallation	Only a qualified installer (*1) or qualified service person (*1) is allowed to relocate the air conditioner. It is dangerous for the air conditioner to be relocated by an unqualified individual since a fire, electric shocks, injury, water leakage, noise and / or vibration may result. Check the following items after reinstallation. <ol style="list-style-type: none"> 1) The earth wire is correctly connected. 2) The power cord is not caught in the product. 3) There is no inclination or unsteadiness and the installation is stable. If check is not executed, a fire, an electric shock or an injury is caused. When carrying out the reclaim work shut down the compressor before disconnecting the refrigerant pipe. Disconnecting the refrigerant pipe with the service valve left open and the compressor still operating will cause air, etc. to be sucked in, raising the pressure inside the refrigeration cycle to an abnormally high level, and possibly resulting in reputing, injury, etc.

(*1) Refer to the "Definition of Qualified Installer or Qualified Service Person"

 Cooling check	<p>When the service panel of the outdoor unit is to be opened in order for the compressor or the area around this part to be repaired immediately after the air conditioner has been shut down, set the circuit breaker to the OFF position, and then wait at least 10 minutes before opening the service panel. If you fail to heed this warning, you will run the risk of burning yourself because the compressor pipes and other parts will be very hot to the touch. In addition, before proceeding with the repair work, wear the kind of insulated heat-resistant gloves designed to protect electricians.</p>
	<p>Take care not to get burned by compressor pipes or other parts when checking the cooling cycle while running the unit as they get heated while running. Be sure to put on gloves providing protection for heat.</p>
 Installation	<p>When the service panel of the outdoor unit is to be opened in order for the fan motor, reactor, inverter or the areas around these parts to be repaired immediately after the air conditioner has been shut down, set the circuit breaker to the OFF position, and then wait at least 10 minutes before opening the service panel. If you fail to heed this warning, you will run the risk of burning yourself because the fan motor, reactor, inverter heat sink and other parts will be very hot to the touch. In addition, before proceeding with the repair work, wear the kind of insulated heat-resistant gloves designed to protect electricians.</p>
	<p>Only a qualified installer or service person is allowed to do installation work. Inappropriate installation may result in water leakage, electric shock or fire.</p>
	<p>Before starting to install the air conditioner, read carefully through the Installation Manual, and follow its instructions to install the air conditioner.</p>
	<p>Be sure to use the company-specified products for the separately purchased parts. Use of non-specified products may result in fire, electric shock, water leakage or other failure. Have the installation performed by a qualified installer.</p>
	<p>Do not supply power from the power terminal block equipped on the outdoor unit to another outdoor unit. Capacity overflow may occur on the terminal block and may result in fire.</p>
	<p>Do not install the air conditioner in a location that may be subject to a risk of exposure to a combustible gas. If a combustible gas leaks and becomes concentrated around the unit, a fire may occur.</p>
	<p>Install the indoor unit at least 2.5 m above the floor level since otherwise the users may injure themselves or receive electric shocks if they poke their fingers or other objects into the indoor unit while the air conditioner is running.</p>
	<p>Install a circuit breaker that meets the specifications in the installation manual and the stipulations in the local regulations and laws.</p>
	<p>Install the circuit breaker where it can be easily accessed by the qualified service person (*1).</p>
	<p>If you install the unit in a small room, take appropriate measures to prevent the refrigerant from exceeding the limit concentration even if it leaks. Consult the dealer from whom you purchased the air conditioner when you implement the measures. Accumulation of highly concentrated refrigerant may cause an oxygen deficiency accident.</p>
<p>Do not place any combustion appliance in a place where it is directly exposed to the wind of air conditioner, otherwise it may cause imperfect combustion.</p>	
<p>When mounting the rails, push them until the 3 latches click. (Concealed duct type only)</p>	

Explanations given to user

If you have discovered that the fan grille is damaged, do not approach the outdoor unit but set the circuit breaker to the OFF position, and contact a qualified service person to have the repairs done. Do not set the circuit breaker to the ON position until the repairs are completed.

Relocation

- Only a qualified installer (*1) or qualified service person (*1) is allowed to relocate the air conditioner. It is dangerous for the air conditioner to be relocated by an unqualified individual since a fire, electric shocks, injury, water leakage, noise and / or vibration may result.
- When carrying out the reclaim work shut down the compressor before disconnecting the refrigerant pipe. Disconnecting the refrigerant pipe with the service valve left open and the compressor still operating will cause air, etc. to be sucked in, raising the pressure inside the refrigeration cycle to an abnormally high level, and possibly resulting in rupturing, injury, etc.

(*1) Refer to the "Definition of Qualified Installer or Qualified Service Person"

1. SPECIFICATIONS

MODEL NAME	MMD-UP***1SPHY-E/TR	003	005	007	009	012	015	018	024	027		
Cooling/Heating Capacity (*1)	kW	0.9/1.0	1.7/1.9	2.2/2.5	2.8/3.2	3.6/4.0	4.5/5.0	5.6/6.3	7.1/8.0	8.0/9.0		
Electrical characteristics (50/60Hz)	Power supply		1 phase 220-240V ~ 50H 208-230V ~ 60Hz									
	Factory setting	Running current	A	0.34 / 0.36	0.36 / 0.37	0.40 / 0.42	0.42 / 0.44	0.44 / 0.46	0.47 / 0.49	0.53 / 0.56	0.69 / 0.73	0.74 / 0.78
		Power consumption	kW	0.018 / 0.018	0.020 / 0.020	0.026 / 0.026	0.029 / 0.029	0.031 / 0.031	0.035 / 0.035	0.044 / 0.044	0.067 / 0.067	0.072 / 0.072
		Starting current	A	0.60 / 0.63	0.62 / 0.65	0.69 / 0.73	0.73 / 0.77	0.77 / 0.81	0.82 / 0.86	0.92 / 0.97	1.21 / 1.27	1.30 / 1.36
	Standard ESP (*2)	Running current	A	0.37 / 0.39	0.40 / 0.41	0.46 / 0.48	0.48 / 0.50	0.52 / 0.54	0.54 / 0.57	0.60 / 0.63	0.83 / 0.87	0.88 / 0.93
		Power consumption	kW	0.024 / 0.024	0.026 / 0.026	0.035 / 0.035	0.038 / 0.038	0.043 / 0.043	0.046 / 0.046	0.054 / 0.054	0.086 / 0.086	0.092 / 0.092
Starting current		A	0.65 / 0.69	0.69 / 0.73	0.81 / 0.85	0.84 / 0.88	0.90 / 0.95	0.95 / 0.99	1.04 / 1.10	1.45 / 1.53	1.54 / 1.62	
Appearance		Zinc hot dipping steel plate										
Dimension	Height	mm	210									
	Width	mm	700				900			1100		
	Depth	mm	450									
Net Weight	kg	15				18			21			
Total Weight	kg	19				23			26			
Heat exchanger		Finned tube										
Soundproof / Heat-insulating material		Polyethylene foam + Polyurethane foam										
Fan unit	Fan	Centrifugal fan (Sirocco fan)										
	Motor output	W	50				94					
Airflow	Standard	m³/h	410	450	540	570	600	690	780	1080	1140	
	Mid.+	m³/h	390	430	500	530	550	660	760	1010	1060	
	Mid	m³/h	370	410	460	500	520	640	730	950	980	
	Low+	m³/h	360	390	430	460	470	590	690	900	940	
	Low	m³/h	350	380	400	420	440	550	650	860	910	
External Static Pressure (*Factory setting)		Pa	10* - 20 - 30 - 40 -50 (5steps)									
Controller		Remote controller										
Air filter		Standard filter (Long life filter)										
Connecting pipe	Gas side	mm	Dia.9.5				Dia.12.7			Dia.15.9		
	Liquid side	mm	Dia.6.4						Dia.9.5			
Drain port (Nominal dia. mm)		25 (Polyvinyl chloride tube)										

(Continued)

MODEL NAME	MMD-UP***1SPHY-E/TR		003	005	007	009	012	015	018	024	027	
Sound pressure level <Factory setting>	Under air inlet	High	dBA	37	39	41	42	44	42	44	47	48
		Mid.+	dBA	36	38	40	41	42	40	43	46	47
		Mid.	dBA	35	37	39	40	40	39	42	44	45
		Low+	dBA	34	35	38	38	39	38	41	43	44
		Low	dBA	32	34	35	36	37	37	39	41	43
	Back air inlet	High	dBA	29	30	31	32	33	33	34	36	37
		Mid.+	dBA	28	29	30	31	32	31	33	35	36
		Mid.	dBA	27	28	29	29	30	30	32	33	34
		Low+	dBA	26	27	28	28	29	29	31	32	33
		Low	dBA	25	26	26	26	27	28	29	30	32
Sound power level <Factory setting>	High	dBA	46	49	52	54	54	52	56	60	61	
	Mid.+	dBA	45	47	51	52	51	51	55	58	59	
	Mid.	dBA	44	46	49	50	50	50	54	56	58	
	Low+	dBA	43	45	47	48	48	49	52	55	56	
	Low	dBA	42	44	45	46	46	46	51	53	55	
Sound pressure level <Standard external static pressure(*2)>	Under air inlet	High	dBA	39	41	43	44	46	45	46	50	51
		Mid.+	dBA	38	40	42	43	44	43	45	49	50
		Mid.	dBA	37	39	41	42	42	42	44	47	48
		Low+	dBA	36	37	40	40	41	40	43	46	47
		Low	dBA	34	36	37	38	39	39	41	44	46
	Back air inlet	High	dBA	31	32	33	34	35	35	36	39	40
		Mid.+	dBA	30	31	32	33	34	34	35	38	39
		Mid.	dBA	29	30	31	31	32	32	34	36	37
		Low+	dBA	28	29	30	30	31	31	33	35	36
		Low	dBA	27	28	28	28	29	30	31	33	35
Sound power level <Standard external static pressure(*2)>	High	dBA	51	53	54	56	57	55	57	64	65	
	Mid.+	dBA	50	52	52	54	56	54	56	63	64	
	Mid.	dBA	49	51	49	52	53	53	55	60	61	
	Low+	dBA	48	49	48	50	51	52	54	59	60	
	Low	dBA	47	48	46	49	49	49	52	58	59	

Note

(*1) Rated conditions Cooling: Indoor 27 degC Dry Bulb / 19 degC Wet Bulb, Outdoor 35 degC Dry Bulb.
Heating: Indoor 20 degC Dry Bulb, Outdoor 7 degC Dry Bulb / 6 degC Wet Bulb.
Based on equivalent piping length of 7.5 m and piping height difference of 0 m.

(*2) Standard external static pressure UP003~018:30Pa, UP024~027:40Pa.

2. FAN CHARACTERISTICS

003 type

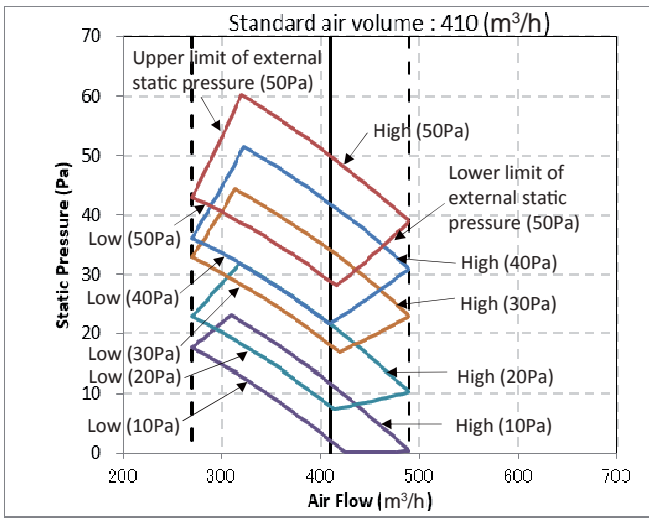

005 type

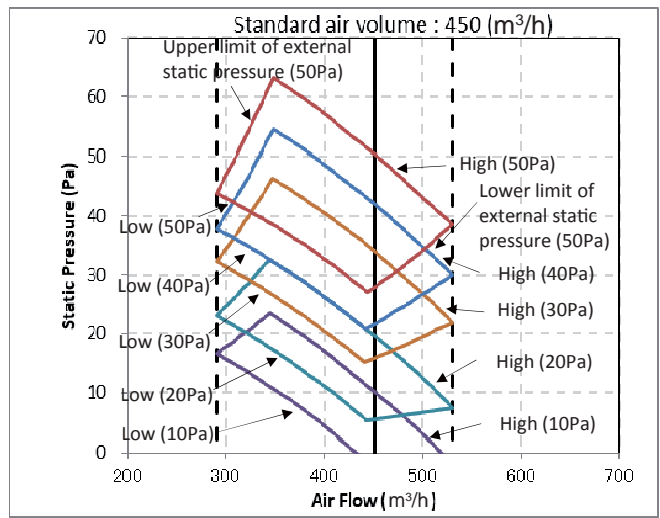

007 type

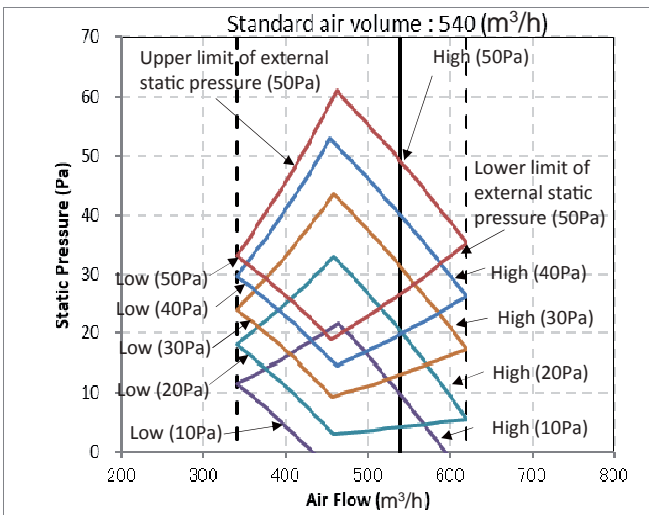

009 type

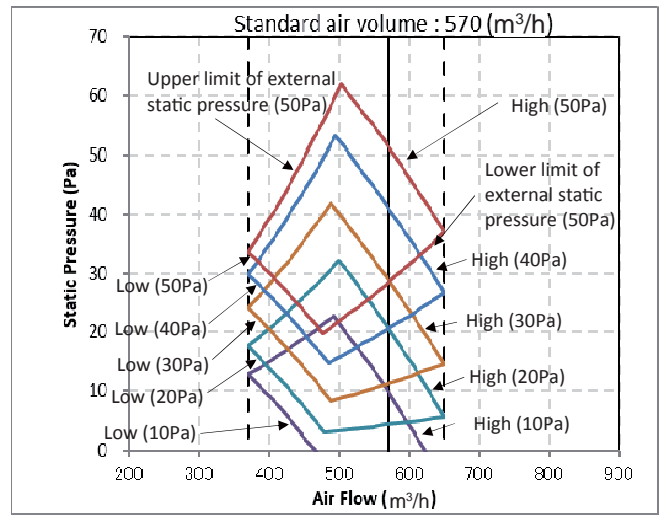

012 type

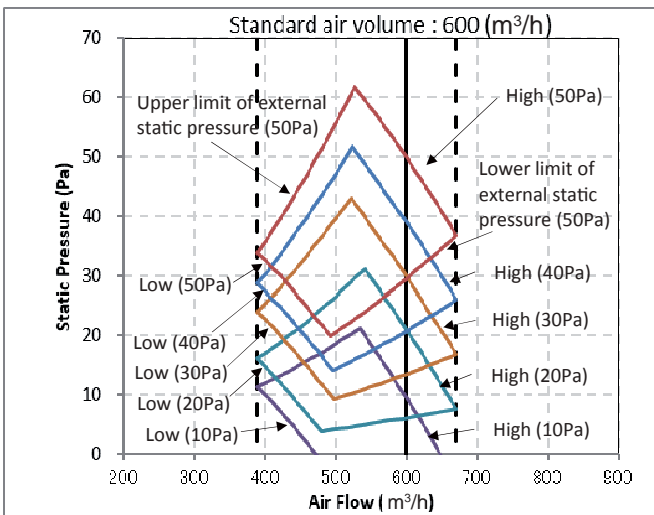

015 type

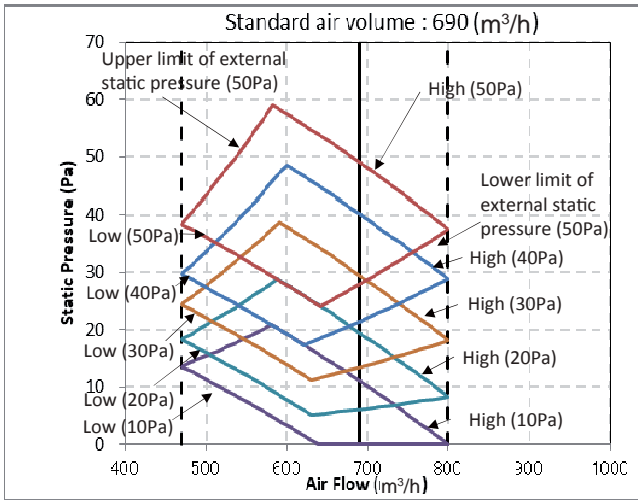

018 type

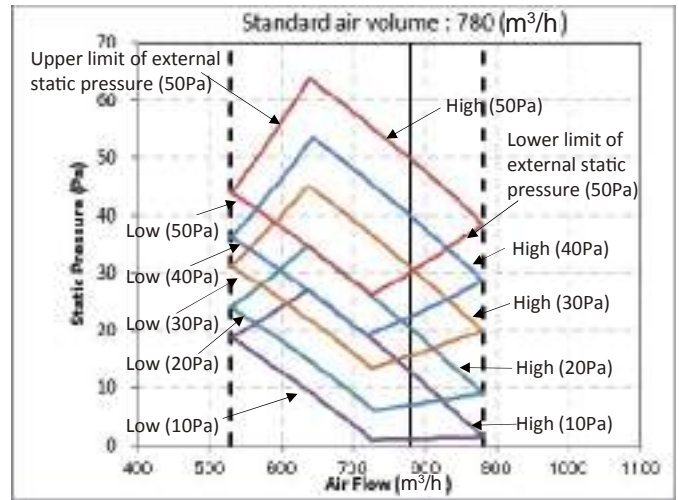

024 type

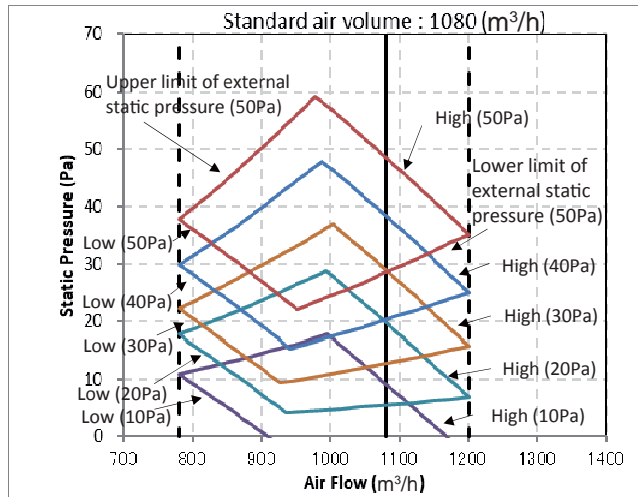

027 type

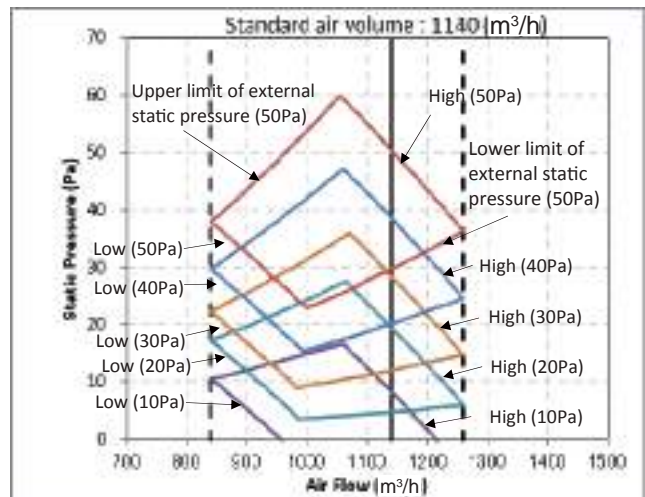

3. CONSTRUCTION VIEWS (EXTERNAL VIEWS)

Space required for installation and servicing

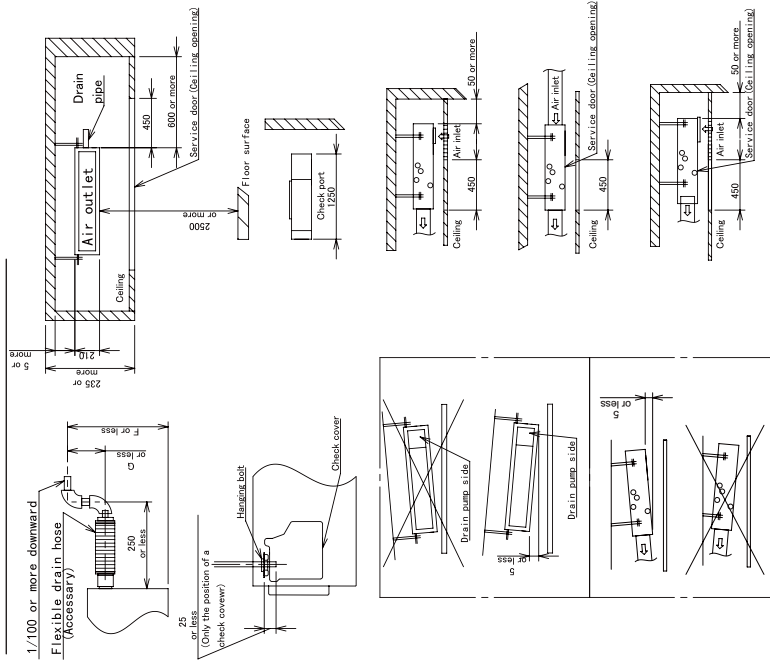

(Unit : mm)

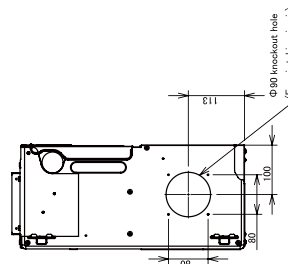
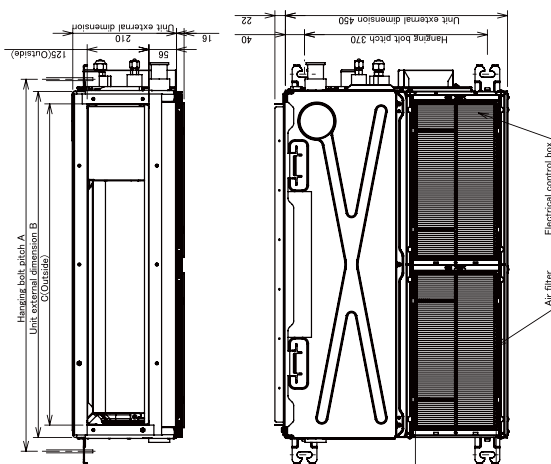
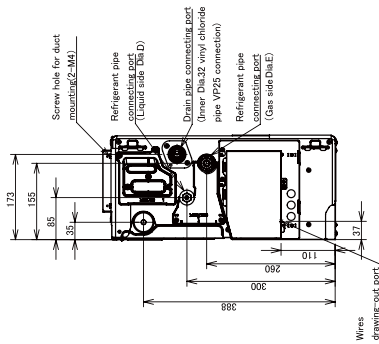

MW-IP***SPRY-E MD-UP***SPRY-TR	003-012	015-018	024~027
A	770	970	1170
B	700	900	1100
C	650	850	1050
D	9.5	12.7	15.9
E	6.4	9.5	12.7
F	550	650	750
G	380	480	580

4. WIRING DIAGRAMS

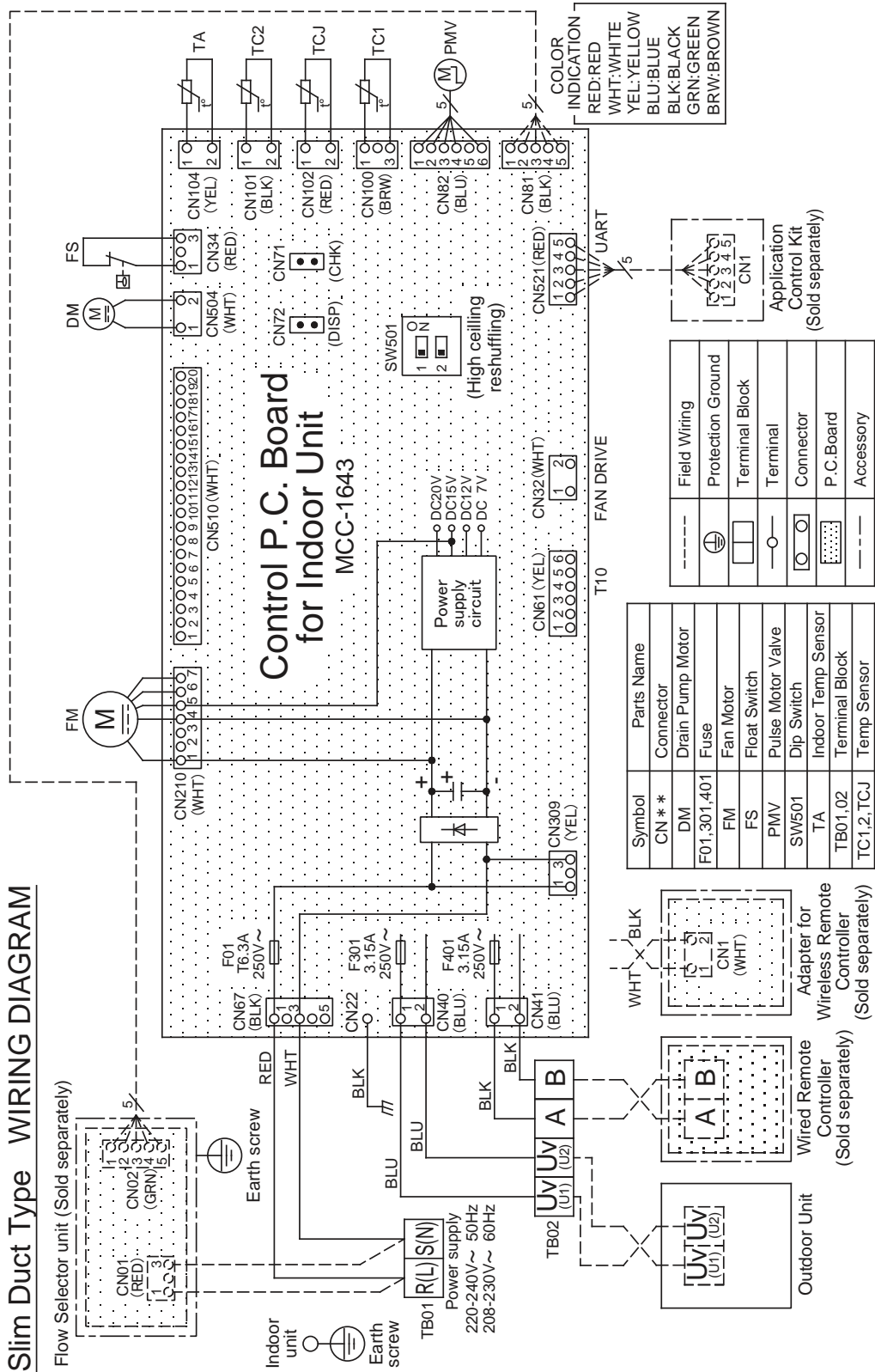

5. PARTS RATING

Model	MMD-UP***1SPHY*	003	005	007	009	012	015	018	024	027	
Fan motor		ICF-340WD50-1					ICF-340WD94-3				
Drain pump motor		MDP-1401									
Float switch		FS-1A-31									
Pulse motor valve		PAM-B25YGTF-1					PAM-B40YGTF-1				
P.C. board		MCC-1643									
TA sensor		Lead wire length : 328mm Vinyl tube									
TC1 sensor		Dia.4 size lead wire length : 1200mm Vinyl tube (Blue)									
TC2 sensor		Dia.6 size lead wire length : 1000mm Vinyl tube (Black)									
TCJ sensor		Dia.6 size lead wire length : 1000mm Vinyl tube (Red)									

6. REFRIGERATION CYCLE DIAGRAM

Indoor unit

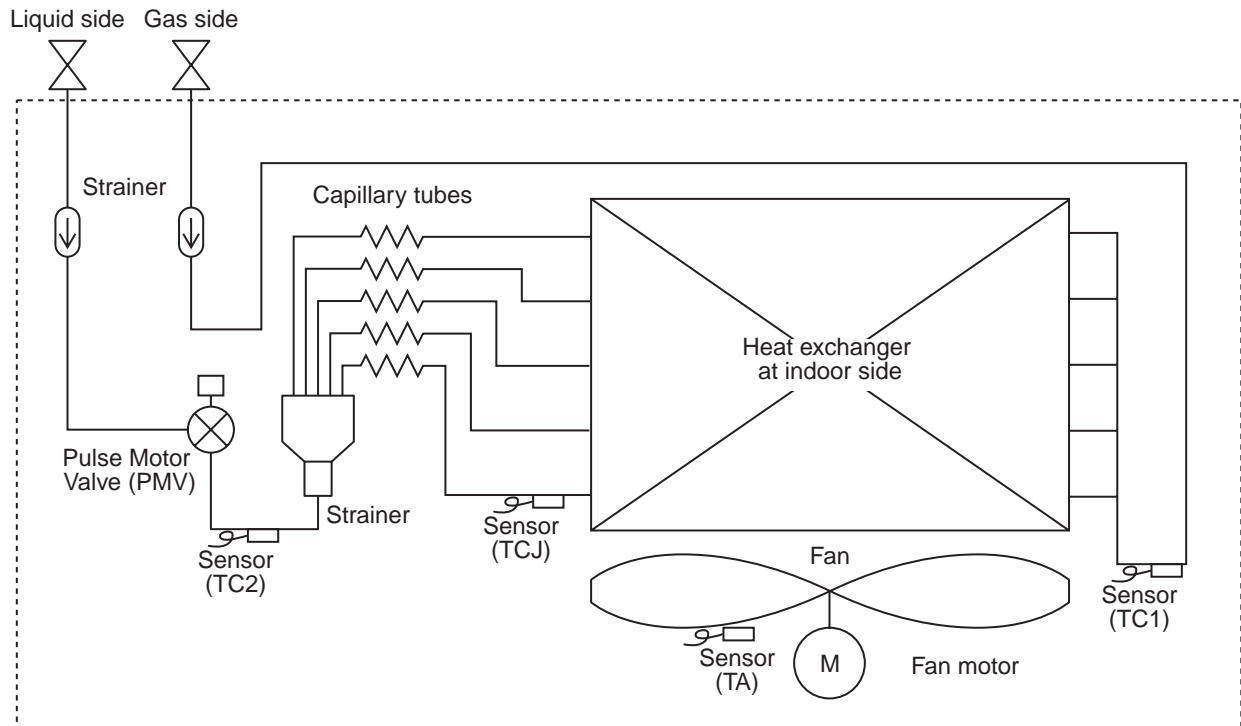

Explanation of functional parts in indoor unit

Functional part name		Functional outline
Pulse Motor Valve	PMV	(Connector CN82 (6P): Blue) 1) Controls superheat in cooling operation 2) Controls subcool in heating operation 3) Recovers refrigerant oil in cooling operation 4) Recovers refrigerant oil in heating operation
Temp. sensor	1. TA	(Connector CN104 (2P): Yellow) 1) Detects indoor suction temperature
	2. TC1	(Connector CN100 (3P): Brown) 1) Controls PMV superheat in cooling operation
	3. TC2	(Connector CN101 (2P): Black) 1) Controls PMV subcool in heating operation
	4. TCJ	(Connector CN102 (2P): Red) 1) Controls PMV superheat in cooling operation

7. CONTROL OUTLINE

7-1. Control Specifications

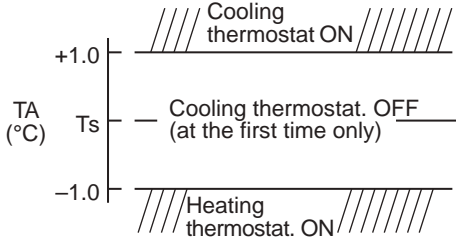
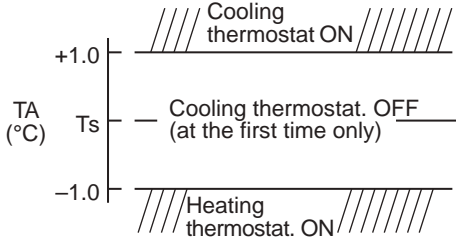
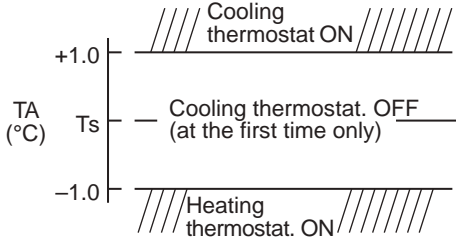
No.	Item	Outline of specifications	Remarks														
1	When power supply is reset	1) Distinction of outdoor unit When the power supply is reset, the outdoors are distinguished and the control is selected according to the distinguished result. 2) Setting of indoor fan speed and existence of air direction adjustment Based on EEPROM data, select setting of the indoor fan speed and the existence of air direction adjustment. 3) If resetting the power supply during occurrence of a trouble, the check code is once cleared. After ON/OFF button of the remote controller was pushed and the operation was resumed, if the abnormal status continues, the check code is again displayed on the remote controller.															
2	Operation mode selection	1) Based on the operation mode selecting command from the remote controller, the operation mode is selected. <table border="1" data-bbox="448 853 1117 1872" style="margin: 10px auto;"> <thead> <tr> <th data-bbox="448 853 638 947">Remote controller command</th> <th data-bbox="638 853 1117 947">Control outline</th> </tr> </thead> <tbody> <tr> <td data-bbox="448 947 638 987">STOP</td> <td data-bbox="638 947 1117 987">Operation stops.</td> </tr> <tr> <td data-bbox="448 987 638 1028">FAN</td> <td data-bbox="638 987 1117 1028">Fan operation</td> </tr> <tr> <td data-bbox="448 1028 638 1068">COOL</td> <td data-bbox="638 1028 1117 1068">Cooling operation</td> </tr> <tr> <td data-bbox="448 1068 638 1108">DRY</td> <td data-bbox="638 1068 1117 1108">Dry operation</td> </tr> <tr> <td data-bbox="448 1108 638 1149">HEAT</td> <td data-bbox="638 1108 1117 1149">Heating operation</td> </tr> <tr> <td data-bbox="448 1149 638 1384">AUTO</td> <td data-bbox="638 1149 1117 1384"> <ul style="list-style-type: none"> • TA and Ts automatically select COOL/ HEAT operation mode for operation. • The operation is performed as shown in the following figure according to TA value at the first time only. (In the range of $T_s - 1 < TA < T_s + 1$, Cooling thermostat OFF (Fan) / Setup air volume operation continues.)  </td> </tr> </tbody> </table> <p data-bbox="448 1668 1117 1872">* Automatic mode is able to be selected only in heat recovery system outdoor unit type. While a wireless remote controller is used, the mode is notified by "Pi Pi" (two times) receiving sound and the alternate flashing of [TIMER ☺] and [READY ☺]. To clear the alternate flashing, change the mode on the wireless remote controller.</p>	Remote controller command	Control outline	STOP	Operation stops.	FAN	Fan operation	COOL	Cooling operation	DRY	Dry operation	HEAT	Heating operation	AUTO	<ul style="list-style-type: none"> • TA and Ts automatically select COOL/ HEAT operation mode for operation. • The operation is performed as shown in the following figure according to TA value at the first time only. (In the range of $T_s - 1 < TA < T_s + 1$, Cooling thermostat OFF (Fan) / Setup air volume operation continues.) 	TA: Room temp. Ts: Setup temp.
Remote controller command	Control outline																
STOP	Operation stops.																
FAN	Fan operation																
COOL	Cooling operation																
DRY	Dry operation																
HEAT	Heating operation																
AUTO	<ul style="list-style-type: none"> • TA and Ts automatically select COOL/ HEAT operation mode for operation. • The operation is performed as shown in the following figure according to TA value at the first time only. (In the range of $T_s - 1 < TA < T_s + 1$, Cooling thermostat OFF (Fan) / Setup air volume operation continues.) 																
3	Room temp. control	1) Adjustment range: Remote controller setup temperature (°C) <table border="1" data-bbox="448 1955 1117 2078" style="margin: 10px auto;"> <thead> <tr> <th data-bbox="448 1955 638 1995"></th> <th data-bbox="638 1955 813 1995">COOL/DRY</th> <th data-bbox="813 1955 965 1995">HEAT</th> <th data-bbox="965 1955 1117 1995">AUTO*</th> </tr> </thead> <tbody> <tr> <td data-bbox="448 1995 638 2036">Wired type</td> <td data-bbox="638 1995 813 2036">18 to 29</td> <td data-bbox="813 1995 965 2036">18 to 29</td> <td data-bbox="965 1995 1117 2036">18 to 29</td> </tr> <tr> <td data-bbox="448 2036 638 2078">Wireless type</td> <td data-bbox="638 2036 813 2078">17 to 30</td> <td data-bbox="813 2036 965 2078">17 to 30</td> <td data-bbox="965 2036 1117 2078">17 to 27</td> </tr> </tbody> </table>		COOL/DRY	HEAT	AUTO*	Wired type	18 to 29	18 to 29	18 to 29	Wireless type	17 to 30	17 to 30	17 to 27	* Heat recovery system outdoor unit type only		
	COOL/DRY	HEAT	AUTO*														
Wired type	18 to 29	18 to 29	18 to 29														
Wireless type	17 to 30	17 to 30	17 to 27														

No.	Item	Outline of specifications	Remarks												
3	Room temp. control (Continued)	2) By setting the CODE No. 06, the setup temperature in heating operation can be compensated. <table border="1" data-bbox="453 286 1117 371" style="margin: 10px auto;"> <tr> <td style="text-align: center;">Setup data</td> <td style="text-align: center;">0</td> <td style="text-align: center;">2</td> <td style="text-align: center;">4</td> <td style="text-align: center;">6</td> </tr> <tr> <td style="text-align: center;">Setup temp. compensation</td> <td style="text-align: center;">+0°C</td> <td style="text-align: center;">+2°C</td> <td style="text-align: center;">+4°C</td> <td style="text-align: center;">+6°C</td> </tr> </table> The initial factory default value <table border="1" data-bbox="453 427 742 472" style="margin: 10px auto;"> <tr> <td style="text-align: center;">Setup data</td> <td style="text-align: center;">2</td> </tr> </table>	Setup data	0	2	4	6	Setup temp. compensation	+0°C	+2°C	+4°C	+6°C	Setup data	2	Suction air temperature shift of heating operation Except while sensor of the remote controller is controlled
Setup data	0	2	4	6											
Setup temp. compensation	+0°C	+2°C	+4°C	+6°C											
Setup data	2														
4	Automatic capacity control	1) Based on the difference between TA and Ts, the operation capacity is determined by the outdoor unit. <div style="display: flex; justify-content: space-around; align-items: flex-start; margin-top: 20px;"> <div data-bbox="469 622 735 1010" style="text-align: center;"> <p>COOL</p> </div> <div data-bbox="820 622 1086 1010" style="text-align: center;"> <p>HEAT</p> </div> </div>	Ts: Setup temp. TA: Room temp.												
5	Automatic cooling/heating control * Heat recovery system outdoor unit type only	1) The judgment of selecting COOL/HEAT is carried out as shown below. When TA exceeds Tsh by 1.5 for 10 minutes, the operation is thermostat OFF then, the heating operation (thermostat OFF) is changed to cooling operation. <div style="text-align: center; margin-top: 20px;"> </div> <p style="margin-top: 10px;">*Description in the parentheses shows an example of cooling ON/OFF.</p> <p>When TA is less than Tsh by 1.5 for 10 minutes, the operation is thermostat OFF then, the cooling operation (thermostat OFF) is changed to heating operation.</p> 2) For the automatic capacity control after judgment of cooling/heating, refer to item No.4. 3) For temperature compensation of room temp. control in automatic heating, refer to item No.3.	Tsc: Setup temp. in cooling operation Tsh: Setup temp. in heating operation + temp. compensation of room temp. control												

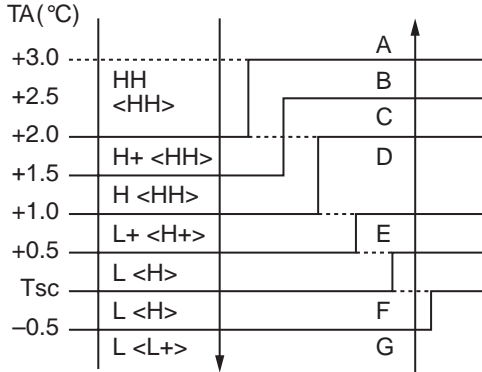
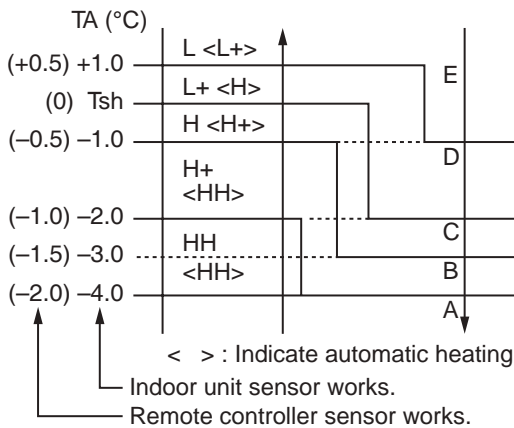
No.	Item	Outline of specifications	Remarks
6	Fan speed selection	<p>1) Operation with (HH), (H+), (H), (L+), (L) or [AUTO] mode is carried out by the command from the remote controller.</p> <p>2) When the fan speed mode [AUTO] is selected, the fan speed varies by the difference between TA and Ts.</p> <p><COOL></p>  <p style="text-align: center;">< > : Indicate automatic cooling.</p> <ul style="list-style-type: none"> Controlling operation in case when thermo of remote controller works is same as a case when thermo of the body works. If the fan speed has been changed once, it is not changed for 3 minutes. However when the air volume is changed, the fan speed changes. When cooling operation has started, select a downward slope for the air speed, that is, the high position. If the temperature is at the difference boundary, the fan speed is not changed. <p><HEAT></p>  <p style="text-align: center;">< > : Indicate automatic heating.</p> <p style="text-align: center;">↑ Indoor unit sensor works. ↓ Remote controller sensor works.</p> <p>() : indicate the value when the remote controller sensor is worked.</p> <ul style="list-style-type: none"> If the fan speed has been changed once, it is not changed for 1 minute. However when the air speed changed, the fan speed changes. When heating operation has started, select an upward slope for the fan speed, that is, the high position. If the temperature is at the difference boundary, the fan speed is not changed. If $TC2 \geq 60^{\circ}C$, the fan speed increases by 1 step. 	<p>HH > H+ > H > L+ > L > UL Depends on fan speed mode selection at the remote controller. (H+) and (L+) cannot be selected.</p> <p>Code No. 32 0000: Indoor unit sensor (Main unit) 0001: Remote controller sensor.</p> <p>TC2: Indoor heat exchanger sensor temperature</p>

No.	Item	Outline of specifications	Remarks																																																																																																																																																																																											
6	Fan speed selection (Continued):		Setting of external static pressure mode at code no. [5D] or at SW501 on P.C. board.																																																																																																																																																																																											
MMD-UP0031SPHY-E/TR, MMD-UP0051SPHY-E/TR																																																																																																																																																																																														
<table border="1" style="width: 100%; border-collapse: collapse;"> <thead> <tr> <th data-bbox="539 405 651 472">CODE No. [5d]</th> <th colspan="2" data-bbox="651 405 810 472">Factory default</th> <th colspan="2" data-bbox="810 405 970 472">Type1</th> <th colspan="2" data-bbox="970 405 1129 472">Type3</th> <th colspan="2" data-bbox="1129 405 1289 472">Type4</th> <th colspan="2" data-bbox="1289 405 1433 472">Type6</th> </tr> <tr> <td></td> <td colspan="2" style="text-align: center;">0000</td> <td colspan="2" style="text-align: center;">0001</td> <td colspan="2" style="text-align: center;">0003</td> <td colspan="2" style="text-align: center;">0004</td> <td colspan="2" style="text-align: center;">0006</td> </tr> <tr> <td data-bbox="539 472 651 539">SW501 (1)(2)</td> <td colspan="2" style="text-align: center;">OFF-OFF</td> <td colspan="2" style="text-align: center;">ON-OFF</td> <td colspan="2" style="text-align: center;">OFF-ON</td> <td colspan="2" style="text-align: center;">-</td> <td colspan="2" style="text-align: center;">ON-ON</td> </tr> <tr> <td data-bbox="539 539 651 573">Tap</td> <td data-bbox="651 539 730 573">COOL</td> <td data-bbox="730 539 810 573">HEAT</td> <td data-bbox="810 539 890 573">COOL</td> <td data-bbox="890 539 970 573">HEAT</td> <td data-bbox="970 539 1050 573">COOL</td> <td data-bbox="1050 539 1129 573">HEAT</td> <td data-bbox="1129 539 1209 573">COOL</td> <td data-bbox="1209 539 1289 573">HEAT</td> <td data-bbox="1289 539 1369 573">COOL</td> <td data-bbox="1369 539 1433 573">HEAT</td> </tr> </thead> <tbody> <tr><td>F1</td><td></td><td></td><td></td><td></td><td></td><td></td><td></td><td></td><td>HH</td><td>HH</td></tr> <tr><td>F2</td><td></td><td></td><td></td><td></td><td></td><td></td><td>HH</td><td>HH</td><td>H+</td><td>H+</td></tr> <tr><td>F3</td><td></td><td></td><td></td><td></td><td>HH</td><td>HH</td><td>H+</td><td>H+</td><td>H</td><td>H</td></tr> <tr><td>F4</td><td></td><td></td><td></td><td></td><td>H+</td><td>H+</td><td>H</td><td>H</td><td>L+</td><td>L+</td></tr> <tr><td>F5</td><td></td><td></td><td></td><td></td><td>H</td><td>H</td><td>L+</td><td>L+</td><td>L</td><td>L</td></tr> <tr><td>F6</td><td></td><td></td><td>HH</td><td>HH</td><td>L+</td><td>L+</td><td>L</td><td>L</td><td></td><td></td></tr> <tr><td>F7</td><td></td><td></td><td>H+</td><td>H+</td><td>L</td><td>L</td><td></td><td></td><td></td><td></td></tr> <tr><td>F8</td><td>HH</td><td>HH</td><td>H</td><td>H</td><td></td><td></td><td></td><td></td><td></td><td></td></tr> <tr><td>F9</td><td>H+</td><td>H+</td><td>L+</td><td>L+</td><td></td><td></td><td></td><td></td><td></td><td></td></tr> <tr><td>FA</td><td>H</td><td>H</td><td>L</td><td>L</td><td></td><td></td><td></td><td></td><td></td><td></td></tr> <tr><td>FB</td><td>L+</td><td>L+</td><td></td><td></td><td></td><td></td><td></td><td></td><td></td><td></td></tr> <tr><td>FC</td><td>L</td><td>L</td><td></td><td></td><td></td><td></td><td></td><td></td><td></td><td></td></tr> <tr><td>FD</td><td>LL</td><td>LL</td><td>LL</td><td>LL</td><td>LL</td><td>LL</td><td>LL</td><td>LL</td><td>LL</td><td>LL</td></tr> </tbody> </table>				CODE No. [5d]	Factory default		Type1		Type3		Type4		Type6			0000		0001		0003		0004		0006		SW501 (1)(2)	OFF-OFF		ON-OFF		OFF-ON		-		ON-ON		Tap	COOL	HEAT	COOL	HEAT	COOL	HEAT	COOL	HEAT	COOL	HEAT	F1									HH	HH	F2							HH	HH	H+	H+	F3					HH	HH	H+	H+	H	H	F4					H+	H+	H	H	L+	L+	F5					H	H	L+	L+	L	L	F6			HH	HH	L+	L+	L	L			F7			H+	H+	L	L					F8	HH	HH	H	H							F9	H+	H+	L+	L+							FA	H	H	L	L							FB	L+	L+									FC	L	L									FD	LL	LL	LL	LL	LL	LL	LL	LL	LL	LL
CODE No. [5d]	Factory default		Type1		Type3		Type4		Type6																																																																																																																																																																																					
	0000		0001		0003		0004		0006																																																																																																																																																																																					
SW501 (1)(2)	OFF-OFF		ON-OFF		OFF-ON		-		ON-ON																																																																																																																																																																																					
Tap	COOL	HEAT	COOL	HEAT	COOL	HEAT	COOL	HEAT	COOL	HEAT																																																																																																																																																																																				
F1									HH	HH																																																																																																																																																																																				
F2							HH	HH	H+	H+																																																																																																																																																																																				
F3					HH	HH	H+	H+	H	H																																																																																																																																																																																				
F4					H+	H+	H	H	L+	L+																																																																																																																																																																																				
F5					H	H	L+	L+	L	L																																																																																																																																																																																				
F6			HH	HH	L+	L+	L	L																																																																																																																																																																																						
F7			H+	H+	L	L																																																																																																																																																																																								
F8	HH	HH	H	H																																																																																																																																																																																										
F9	H+	H+	L+	L+																																																																																																																																																																																										
FA	H	H	L	L																																																																																																																																																																																										
FB	L+	L+																																																																																																																																																																																												
FC	L	L																																																																																																																																																																																												
FD	LL	LL	LL	LL	LL	LL	LL	LL	LL	LL																																																																																																																																																																																				
MMD-UP0071SPHY-E/TR, MMD-UP0091SPHY-E/TR, MMD-UP0121SPHY-E/TR																																																																																																																																																																																														
<table border="1" style="width: 100%; border-collapse: collapse;"> <thead> <tr> <th data-bbox="539 1111 651 1178">CODE No. [5d]</th> <th colspan="2" data-bbox="651 1111 810 1178">Factory default</th> <th colspan="2" data-bbox="810 1111 970 1178">Type1</th> <th colspan="2" data-bbox="970 1111 1129 1178">Type3</th> <th colspan="2" data-bbox="1129 1111 1289 1178">Type4</th> <th colspan="2" data-bbox="1289 1111 1433 1178">Type6</th> </tr> <tr> <td></td> <td colspan="2" style="text-align: center;">0000</td> <td colspan="2" style="text-align: center;">0001</td> <td colspan="2" style="text-align: center;">0003</td> <td colspan="2" style="text-align: center;">0004</td> <td colspan="2" style="text-align: center;">0006</td> </tr> <tr> <td data-bbox="539 1178 651 1245">SW501 (1)(2)</td> <td colspan="2" style="text-align: center;">OFF-OFF</td> <td colspan="2" style="text-align: center;">ON-OFF</td> <td colspan="2" style="text-align: center;">OFF-ON</td> <td colspan="2" style="text-align: center;">-</td> <td colspan="2" style="text-align: center;">ON-ON</td> </tr> <tr> <td data-bbox="539 1245 651 1279">Tap</td> <td data-bbox="651 1245 730 1279">COOL</td> <td data-bbox="730 1245 810 1279">HEAT</td> <td data-bbox="810 1245 890 1279">COOL</td> <td data-bbox="890 1245 970 1279">HEAT</td> <td data-bbox="970 1245 1050 1279">COOL</td> <td data-bbox="1050 1245 1129 1279">HEAT</td> <td data-bbox="1129 1245 1209 1279">COOL</td> <td data-bbox="1209 1245 1289 1279">HEAT</td> <td data-bbox="1289 1245 1369 1279">COOL</td> <td data-bbox="1369 1245 1433 1279">HEAT</td> </tr> </thead> <tbody> <tr><td>F1</td><td></td><td></td><td></td><td></td><td></td><td></td><td></td><td></td><td>HH</td><td>HH</td></tr> <tr><td>F2</td><td></td><td></td><td></td><td></td><td></td><td></td><td>HH</td><td>HH</td><td>H+</td><td>H+</td></tr> <tr><td>F3</td><td></td><td></td><td></td><td></td><td>HH</td><td>HH</td><td>H+</td><td>H+</td><td>H</td><td>H</td></tr> <tr><td>F4</td><td></td><td></td><td>HH</td><td>HH</td><td>H+</td><td>H+</td><td>H</td><td>H</td><td></td><td></td></tr> <tr><td>F5</td><td></td><td></td><td></td><td></td><td></td><td></td><td></td><td></td><td>L+</td><td>L+</td></tr> <tr><td>F6</td><td>HH</td><td>HH</td><td>H+</td><td>H+</td><td>H</td><td>H</td><td>L+</td><td>L+</td><td></td><td></td></tr> <tr><td>F7</td><td></td><td></td><td>H</td><td>H</td><td></td><td></td><td></td><td></td><td>L</td><td>L</td></tr> <tr><td>F8</td><td>H+</td><td>H+</td><td></td><td></td><td>L+</td><td>L+</td><td>L</td><td>L</td><td></td><td></td></tr> <tr><td>F9</td><td>H</td><td>H</td><td>L+</td><td>L+</td><td>L</td><td>L</td><td></td><td></td><td></td><td></td></tr> <tr><td>FA</td><td>L+</td><td>L+</td><td>L</td><td>L</td><td></td><td></td><td></td><td></td><td></td><td></td></tr> <tr><td>FB</td><td>L</td><td>L</td><td></td><td></td><td></td><td></td><td></td><td></td><td></td><td></td></tr> <tr><td>FC</td><td></td><td></td><td></td><td></td><td></td><td></td><td></td><td></td><td></td><td></td></tr> <tr><td>FD</td><td>LL</td><td>LL</td><td>LL</td><td>LL</td><td>LL</td><td>LL</td><td>LL</td><td>LL</td><td>LL</td><td>LL</td></tr> </tbody> </table>				CODE No. [5d]	Factory default		Type1		Type3		Type4		Type6			0000		0001		0003		0004		0006		SW501 (1)(2)	OFF-OFF		ON-OFF		OFF-ON		-		ON-ON		Tap	COOL	HEAT	COOL	HEAT	COOL	HEAT	COOL	HEAT	COOL	HEAT	F1									HH	HH	F2							HH	HH	H+	H+	F3					HH	HH	H+	H+	H	H	F4			HH	HH	H+	H+	H	H			F5									L+	L+	F6	HH	HH	H+	H+	H	H	L+	L+			F7			H	H					L	L	F8	H+	H+			L+	L+	L	L			F9	H	H	L+	L+	L	L					FA	L+	L+	L	L							FB	L	L									FC											FD	LL	LL	LL	LL	LL	LL	LL	LL	LL	LL
CODE No. [5d]	Factory default		Type1		Type3		Type4		Type6																																																																																																																																																																																					
	0000		0001		0003		0004		0006																																																																																																																																																																																					
SW501 (1)(2)	OFF-OFF		ON-OFF		OFF-ON		-		ON-ON																																																																																																																																																																																					
Tap	COOL	HEAT	COOL	HEAT	COOL	HEAT	COOL	HEAT	COOL	HEAT																																																																																																																																																																																				
F1									HH	HH																																																																																																																																																																																				
F2							HH	HH	H+	H+																																																																																																																																																																																				
F3					HH	HH	H+	H+	H	H																																																																																																																																																																																				
F4			HH	HH	H+	H+	H	H																																																																																																																																																																																						
F5									L+	L+																																																																																																																																																																																				
F6	HH	HH	H+	H+	H	H	L+	L+																																																																																																																																																																																						
F7			H	H					L	L																																																																																																																																																																																				
F8	H+	H+			L+	L+	L	L																																																																																																																																																																																						
F9	H	H	L+	L+	L	L																																																																																																																																																																																								
FA	L+	L+	L	L																																																																																																																																																																																										
FB	L	L																																																																																																																																																																																												
FC																																																																																																																																																																																														
FD	LL	LL	LL	LL	LL	LL	LL	LL	LL	LL																																																																																																																																																																																				

No.	Item	Outline of specifications	Remarks																																																																																																																																																																																																																																																																																																																																																																																						
6	Fan speed selection (Continued):	<p data-bbox="536 371 1145 398">MMD-UP0151SPHY-E/TR, MMD-UP0181SPHY-E/TR</p> <table border="1" data-bbox="536 405 1433 1043"> <thead> <tr> <th>CODE No. [5d]</th> <th colspan="2">Factory default</th> <th colspan="2">Type1</th> <th colspan="2">Type3</th> <th colspan="2">Type4</th> <th colspan="2">Type6</th> </tr> <tr> <td></td> <td colspan="2">0000</td> <td colspan="2">0001</td> <td colspan="2">0003</td> <td colspan="2">0004</td> <td colspan="2">0006</td> </tr> <tr> <td>SW501 (1)(2)</td> <td colspan="2">OFF-OFF</td> <td colspan="2">ON-OFF</td> <td colspan="2">OFF-ON</td> <td colspan="2">-</td> <td colspan="2">ON-ON</td> </tr> <tr> <td>Tap</td> <td>COOL</td> <td>HEAT</td> <td>COOL</td> <td>HEAT</td> <td>COOL</td> <td>HEAT</td> <td>COOL</td> <td>HEAT</td> <td>COOL</td> <td>HEAT</td> </tr> </thead> <tbody> <tr><td>F1</td><td></td><td></td><td></td><td></td><td></td><td></td><td></td><td></td><td>HH</td><td>HH</td></tr> <tr><td>F2</td><td></td><td></td><td></td><td></td><td></td><td></td><td>HH</td><td>HH</td><td>H+</td><td>H+</td></tr> <tr><td>F3</td><td></td><td></td><td></td><td></td><td></td><td></td><td>H+</td><td>H+</td><td>H</td><td>H</td></tr> <tr><td>F4</td><td></td><td></td><td></td><td></td><td>HH</td><td>HH</td><td>H</td><td>H</td><td>L+</td><td>L+</td></tr> <tr><td>F5</td><td></td><td></td><td></td><td></td><td>H+</td><td>H+</td><td></td><td></td><td></td><td></td></tr> <tr><td>F6</td><td></td><td></td><td>HH</td><td>HH</td><td>H</td><td>H</td><td>L+</td><td>L+</td><td>L</td><td>L</td></tr> <tr><td>F7</td><td></td><td></td><td>H+</td><td>H+</td><td>L+</td><td>L+</td><td></td><td></td><td></td><td></td></tr> <tr><td>F8</td><td>HH</td><td>HH</td><td>H</td><td>H</td><td></td><td></td><td>L</td><td>L</td><td></td><td></td></tr> <tr><td>F9</td><td>H+</td><td>H+</td><td>L+</td><td>L+</td><td>L</td><td>L</td><td></td><td></td><td></td><td></td></tr> <tr><td>FA</td><td>H</td><td>H</td><td></td><td></td><td></td><td></td><td></td><td></td><td></td><td></td></tr> <tr><td>FB</td><td>L+</td><td>L+</td><td>L</td><td>L</td><td></td><td></td><td></td><td></td><td></td><td></td></tr> <tr><td>FC</td><td>L</td><td>L</td><td></td><td></td><td></td><td></td><td></td><td></td><td></td><td></td></tr> <tr><td>FD</td><td>LL</td><td>LL</td><td>LL</td><td>LL</td><td>LL</td><td>LL</td><td>LL</td><td>LL</td><td>LL</td><td>LL</td></tr> </tbody> </table> <p data-bbox="536 1072 1145 1099">MMD-UP0241SPHY-E/TR, MMD-UP0271SPHY-E/TR</p> <table border="1" data-bbox="536 1106 1433 1744"> <thead> <tr> <th>CODE No. [5d]</th> <th colspan="2">Factory default</th> <th colspan="2">Type1</th> <th colspan="2">Type3</th> <th colspan="2">Type4</th> <th colspan="2">Type6</th> </tr> <tr> <td></td> <td colspan="2">0000</td> <td colspan="2">0001</td> <td colspan="2">0003</td> <td colspan="2">0004</td> <td colspan="2">0006</td> </tr> <tr> <td>SW501 (1)(2)</td> <td colspan="2">OFF-OFF</td> <td colspan="2">ON-OFF</td> <td colspan="2">OFF-ON</td> <td colspan="2">-</td> <td colspan="2">ON-ON</td> </tr> <tr> <td>Tap</td> <td>COOL</td> <td>HEAT</td> <td>COOL</td> <td>HEAT</td> <td>COOL</td> <td>HEAT</td> <td>COOL</td> <td>HEAT</td> <td>COOL</td> <td>HEAT</td> </tr> </thead> <tbody> <tr><td>F1</td><td></td><td></td><td></td><td></td><td></td><td></td><td></td><td></td><td>HH</td><td>HH</td></tr> <tr><td>F2</td><td></td><td></td><td></td><td></td><td></td><td></td><td>HH</td><td>HH</td><td>H+</td><td>H+</td></tr> <tr><td>F3</td><td></td><td></td><td></td><td></td><td>HH</td><td>HH</td><td>H+</td><td>H+</td><td></td><td></td></tr> <tr><td>F4</td><td></td><td></td><td></td><td></td><td></td><td></td><td></td><td></td><td>H</td><td>H</td></tr> <tr><td>F5</td><td></td><td></td><td>HH</td><td>HH</td><td>H+</td><td>H+</td><td></td><td></td><td></td><td></td></tr> <tr><td>F6</td><td></td><td></td><td></td><td></td><td></td><td></td><td>H</td><td>H</td><td>L+</td><td>L+</td></tr> <tr><td>F7</td><td>HH</td><td>HH</td><td>H+</td><td>H+</td><td>H</td><td>H</td><td>L+</td><td>L+</td><td>L</td><td>L</td></tr> <tr><td>F8</td><td>H+</td><td>H+</td><td>H</td><td>H</td><td>L+</td><td>L+</td><td>L</td><td>L</td><td></td><td></td></tr> <tr><td>F9</td><td>H</td><td>H</td><td>L+</td><td>L+</td><td>L</td><td>L</td><td></td><td></td><td></td><td></td></tr> <tr><td>FA</td><td>L+</td><td>L+</td><td>L</td><td>L</td><td></td><td></td><td></td><td></td><td></td><td></td></tr> <tr><td>FB</td><td>L</td><td>L</td><td></td><td></td><td></td><td></td><td></td><td></td><td></td><td></td></tr> <tr><td>FC</td><td></td><td></td><td></td><td></td><td></td><td></td><td></td><td></td><td></td><td></td></tr> <tr><td>FD</td><td>LL</td><td>LL</td><td>LL</td><td>LL</td><td>LL</td><td>LL</td><td>LL</td><td>LL</td><td>LL</td><td>LL</td></tr> </tbody> </table> <p data-bbox="517 1778 1390 1805">3) In heating operation, the mode changes to [LL] if thermostat is turned off.</p>	CODE No. [5d]	Factory default		Type1		Type3		Type4		Type6			0000		0001		0003		0004		0006		SW501 (1)(2)	OFF-OFF		ON-OFF		OFF-ON		-		ON-ON		Tap	COOL	HEAT	COOL	HEAT	COOL	HEAT	COOL	HEAT	COOL	HEAT	F1									HH	HH	F2							HH	HH	H+	H+	F3							H+	H+	H	H	F4					HH	HH	H	H	L+	L+	F5					H+	H+					F6			HH	HH	H	H	L+	L+	L	L	F7			H+	H+	L+	L+					F8	HH	HH	H	H			L	L			F9	H+	H+	L+	L+	L	L					FA	H	H									FB	L+	L+	L	L							FC	L	L									FD	LL	LL	LL	LL	LL	LL	LL	LL	LL	LL	CODE No. [5d]	Factory default		Type1		Type3		Type4		Type6			0000		0001		0003		0004		0006		SW501 (1)(2)	OFF-OFF		ON-OFF		OFF-ON		-		ON-ON		Tap	COOL	HEAT	COOL	HEAT	COOL	HEAT	COOL	HEAT	COOL	HEAT	F1									HH	HH	F2							HH	HH	H+	H+	F3					HH	HH	H+	H+			F4									H	H	F5			HH	HH	H+	H+					F6							H	H	L+	L+	F7	HH	HH	H+	H+	H	H	L+	L+	L	L	F8	H+	H+	H	H	L+	L+	L	L			F9	H	H	L+	L+	L	L					FA	L+	L+	L	L							FB	L	L									FC											FD	LL	LL	LL	LL	LL	LL	LL	LL	LL	LL	<p data-bbox="1118 221 1422 338">Setting of external static pressure mode at code no. [5D] or at SW501 on P.C. board.</p>
CODE No. [5d]	Factory default		Type1		Type3		Type4		Type6																																																																																																																																																																																																																																																																																																																																																																																
	0000		0001		0003		0004		0006																																																																																																																																																																																																																																																																																																																																																																																
SW501 (1)(2)	OFF-OFF		ON-OFF		OFF-ON		-		ON-ON																																																																																																																																																																																																																																																																																																																																																																																
Tap	COOL	HEAT	COOL	HEAT	COOL	HEAT	COOL	HEAT	COOL	HEAT																																																																																																																																																																																																																																																																																																																																																																															
F1									HH	HH																																																																																																																																																																																																																																																																																																																																																																															
F2							HH	HH	H+	H+																																																																																																																																																																																																																																																																																																																																																																															
F3							H+	H+	H	H																																																																																																																																																																																																																																																																																																																																																																															
F4					HH	HH	H	H	L+	L+																																																																																																																																																																																																																																																																																																																																																																															
F5					H+	H+																																																																																																																																																																																																																																																																																																																																																																																			
F6			HH	HH	H	H	L+	L+	L	L																																																																																																																																																																																																																																																																																																																																																																															
F7			H+	H+	L+	L+																																																																																																																																																																																																																																																																																																																																																																																			
F8	HH	HH	H	H			L	L																																																																																																																																																																																																																																																																																																																																																																																	
F9	H+	H+	L+	L+	L	L																																																																																																																																																																																																																																																																																																																																																																																			
FA	H	H																																																																																																																																																																																																																																																																																																																																																																																							
FB	L+	L+	L	L																																																																																																																																																																																																																																																																																																																																																																																					
FC	L	L																																																																																																																																																																																																																																																																																																																																																																																							
FD	LL	LL	LL	LL	LL	LL	LL	LL	LL	LL																																																																																																																																																																																																																																																																																																																																																																															
CODE No. [5d]	Factory default		Type1		Type3		Type4		Type6																																																																																																																																																																																																																																																																																																																																																																																
	0000		0001		0003		0004		0006																																																																																																																																																																																																																																																																																																																																																																																
SW501 (1)(2)	OFF-OFF		ON-OFF		OFF-ON		-		ON-ON																																																																																																																																																																																																																																																																																																																																																																																
Tap	COOL	HEAT	COOL	HEAT	COOL	HEAT	COOL	HEAT	COOL	HEAT																																																																																																																																																																																																																																																																																																																																																																															
F1									HH	HH																																																																																																																																																																																																																																																																																																																																																																															
F2							HH	HH	H+	H+																																																																																																																																																																																																																																																																																																																																																																															
F3					HH	HH	H+	H+																																																																																																																																																																																																																																																																																																																																																																																	
F4									H	H																																																																																																																																																																																																																																																																																																																																																																															
F5			HH	HH	H+	H+																																																																																																																																																																																																																																																																																																																																																																																			
F6							H	H	L+	L+																																																																																																																																																																																																																																																																																																																																																																															
F7	HH	HH	H+	H+	H	H	L+	L+	L	L																																																																																																																																																																																																																																																																																																																																																																															
F8	H+	H+	H	H	L+	L+	L	L																																																																																																																																																																																																																																																																																																																																																																																	
F9	H	H	L+	L+	L	L																																																																																																																																																																																																																																																																																																																																																																																			
FA	L+	L+	L	L																																																																																																																																																																																																																																																																																																																																																																																					
FB	L	L																																																																																																																																																																																																																																																																																																																																																																																							
FC																																																																																																																																																																																																																																																																																																																																																																																									
FD	LL	LL	LL	LL	LL	LL	LL	LL	LL	LL																																																																																																																																																																																																																																																																																																																																																																															

No.	Item	Outline of specifications	Remarks
7	Prevention of cold air discharge	<p>In heating operation, the lowest temperature between TC1 sensor and the highest temperature between TC2 and TCJ sensor is set as the upper bound of the fan speed mode control.</p> <ul style="list-style-type: none"> • When B zone has been continuing for 6 minutes, the operation shifts to C zone. • For the defrosting operation, the control point is set to +6°C. <p>A zone: OFF B zone: Over 26°C, below 28°C, ULTRA LOW (LL) C zone: Over 28°C, below 30°C, LOW (L) D zone: Over 30°C, below 32°C, MED (H) E zone: HIGH (HH)</p>	<p>TCJ: Temperature of indoor heat exchanger sensor</p> <ul style="list-style-type: none"> • In D and E zones, priority is given to remote controller fan speed setup. • In A zone “❄” is displayed.

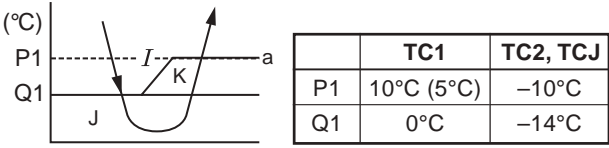
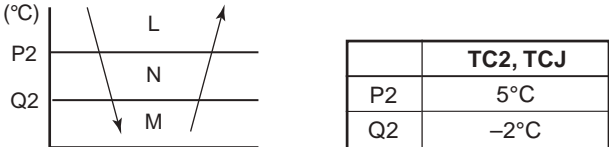

No.	Item	Outline of specifications	Remarks															
8	Freeze prevention control (Low temp. release)	<p>1. In all cooling operation, the air conditioner operates as described below based upon temp. detected by TC1, TC2 and TCJ sensors.</p> <ul style="list-style-type: none"> When "J" zone is detected for 5 minutes, the thermostat is forcedly off. In "K" zone, the timer count is interrupted, and held. When "I" zone is detected, the timer is cleared and the operation returns to the normal operation. If "J" zone continues, operation of the indoor fan in LOW mode continues until it reaches the "I" zone. It is reset when the following conditions are satisfied. <p>Reset conditions</p> <ol style="list-style-type: none"> TC1 $\geq 12^{\circ}\text{C}$ and TC2 $\geq 12^{\circ}\text{C}$ and TCJ $\geq 12^{\circ}\text{C}$ 20 minutes passed after stop.  <table border="1" data-bbox="751 781 1070 891"> <thead> <tr> <th></th> <th>TC1</th> <th>TC2, TCJ</th> </tr> </thead> <tbody> <tr> <td>P1</td> <td>10°C (5°C)</td> <td>-10°C</td> </tr> <tr> <td>Q1</td> <td>0°C</td> <td>-14°C</td> </tr> </tbody> </table> <p>2. In all cooling operation, the air conditioner operates as described below based upon temp. detected by TC2 and TCJ sensors.</p> <ul style="list-style-type: none"> When "M" zone is detected for 45 minutes, the thermostat is forcedly off. In "N" zone, the timer count is interrupted and held. When shifting to "M" zone again, the timer count restarts and continues. If "L" zone is detected, the timer is cleared and the operation returns to normal operation. <p>Reset conditions</p> <ol style="list-style-type: none"> TC1 $\geq 12^{\circ}\text{C}$ and TC2 $\geq 12^{\circ}\text{C}$ and TCJ $\geq 12^{\circ}\text{C}$ 20 minutes passed after stop.  <table border="1" data-bbox="804 1464 1070 1574"> <thead> <tr> <th></th> <th>TC2, TCJ</th> </tr> </thead> <tbody> <tr> <td>P2</td> <td>5°C</td> </tr> <tr> <td>Q2</td> <td>-2°C</td> </tr> </tbody> </table>		TC1	TC2, TCJ	P1	10°C (5°C)	-10°C	Q1	0°C	-14°C		TC2, TCJ	P2	5°C	Q2	-2°C	<p>TC1: Temperature of indoor heat exchanger sensor</p> <p>() value: When the power supply is turned on, the forced thermostat becomes OFF if the temperature is less than this indicated temperature.</p>
	TC1	TC2, TCJ																
P1	10°C (5°C)	-10°C																
Q1	0°C	-14°C																
	TC2, TCJ																	
P2	5°C																	
Q2	-2°C																	
9	Refrigerant (Oil) recovery control in cooling operation	<p>Indoor units during stop/thermostat OFF or FAN operation perform following controls when a refrigerant (compressor oil) recovery signal is received from outdoor unit at the cooling operation,</p> <ol style="list-style-type: none"> Opening the indoor unit PMV at constant valve opening. (For a maximum of about 4 minutes) Operating the drain pump for about one minute, during recovery control and after the control finished. <p>Also, indoor unit fan or louvers may operate depending on the indoor unit type.</p>	<p>Control is performed per two hours or when the outdoor unit determines its need.(It varies depending on the indoor units connected.)</p>															

No.	Item	Outline of specifications	Remarks
10	Refrigerant (Oil) recovery control in heating operation	<p>Indoor units during stop/thermostat OFF or FAN operation perform following controls when a refrigerant (compressor oil) recovery signal is received from outdoor unit at the heating operation,</p> <p>(1) Opening the indoor unit PMV at constant valve opening. (For a maximum of about 20 minutes)</p> <p>(2) TC2 temperature is detected to close its PMV. Also, the fan, louvers, drain pump may operate for about one minute after recovery control finished depending on indoor unit types, until the number of recovery control reaches the predetermined number.</p> <p>NOTE The PMV, indoor fan, or louvers may operate through the outdoor unit instruction. For its detail, refer to the outdoor unit service guide.</p>	<p>Indoor unit during cooling thermostat OFF or FAN operation stops the indoor fan and displays "Operation standby ☺".</p> <p>Control is performed per one hour or when the outdoor unit determines its need.(It varies depending on the indoor units connected.)</p>
11	Compensation control for short intermittent operation	<p>1) For 3 minutes after start of operation, the operation is forcedly continued even if the unit enters in thermostat. OFF condition.</p> <p>2) However the thermostat is OFF giving prior to COOL/HEAT selection, READY ☺ for operation and protective control.</p>	Usually the priority is given to 5 minutes at outdoor controller side.
12	Drain pump control	<p>1) Drain pump operates during cooling operation. (including DRY operation)</p> <p>2) While the drain pump is operating, if the float switch is operated, the outdoor unit will stop operating but the drain pump will keep continuously operating. After that, the check code is issued.</p> <p>3) When the drain pump stops operating, if the float switch is operated, the outdoor unit will stop and the drain pump will start operating. After the float switch is being operating for roughly 5 minutes, the check code will be issued.</p>	Check Code [P10]
13	Elimination of retained heat	<p>1) When the unit stopped from [HEAT] operation, the indoor fan operates with [L] for approx. 30 seconds.</p>	
14	HA control	<p>1) ON/OFF operation is available by input of HA signal from the remote site when connecting to remote controller or the remote ON/OFF interface.</p> <p>2) The HA terminal is ON/OFF depending on HA control output.</p> <p>3) The I/O specifications of HA is in accordance with JEMA standard.</p>	<p>When using HA terminal (CN61) for the remote ON/OFF, a connector sold separately is necessary.</p> <p>In case of group operation, use the connector to connect HA terminal to either header or follower indoor unit.</p>

No.	Item	Outline of specifications	Remarks								
15	Display of [READY] [HEAT READY]	<p>< READY> Displayed on the remote controller</p> <ol style="list-style-type: none"> When the following check codes are indicated <ul style="list-style-type: none"> Open phase of power supply wiring [P05] was detected. There is an indoor unit that detected the indoor overflow [P10]. There is an indoor unit that detected the interlock alarm [L30]. During forced thermostat OFF <ul style="list-style-type: none"> [COOL/DRY] operation is unavailable because the other indoor unit operates with [HEAT] mode. [HEAT] operation is unavailable because COOL priority (SW11-bit1 of the Outdoor I/F P.C. board is ON) is set and the other indoor unit operates with [COOL/DRY] mode. When the indoor unit which is in the condition of 1) or 2) keeps being in thermostat OFF status. When the indoor fan stops because the system performs [Recovery operation for heating refrigerant (Oil)]. <p><HEAT READY> Displayed on the remote controller When the indoor fan stops in order to prevent discharge of cool air when heating operation started or during heating operation. (including the defrost operation during thermostat OFF)</p>	<ul style="list-style-type: none"> < READY> ☺ display No display for wireless type remote controller <HEAT READY> “☼” display 								
16	Alarm output setup	<p>The alarm output from the indoor P.C. board is output in each indoor unit during group control, but it can be set so as to be output in the header unit and follower units. Following the table below, register the setting data in DN Code "79".</p> <table border="1"> <thead> <tr> <th>DN</th> <th>Alarm output of the header indoor unit</th> <th>Setting data</th> </tr> </thead> <tbody> <tr> <td rowspan="2">79</td> <td>Not including the state of follower units</td> <td>0000 (Factory default)</td> </tr> <tr> <td>Including the state of follower units</td> <td>0001</td> </tr> </tbody> </table>	DN	Alarm output of the header indoor unit	Setting data	79	Not including the state of follower units	0000 (Factory default)	Including the state of follower units	0001	<p>Connector CN61 (Refer to Notice code signal)</p> <p>Be sure to change the setting data while operation stops.</p>
DN	Alarm output of the header indoor unit	Setting data									
79	Not including the state of follower units	0000 (Factory default)									
	Including the state of follower units	0001									
17	Display of filter sign [𠄎] (Not provided to the wireless type)	<ol style="list-style-type: none"> The filter sign is displayed with LC by sending the filter-reset signal to the remote controller when the specified time (2500H) elapsed as a result of integration of the operation time of the indoor fan. The integrated timer is cleared when the filter-reset signal is received from the remote controller. In this time, if the specified time elapsed, the counted time is reset and the liquid crystal display is deleted. 	<p>[𠄎 FILTER] goes on. The filter sign is not displayed in RBC-ASCU11-*. </p>								
18	Selection of central control mode	<ol style="list-style-type: none"> Selection of the contents that can be operated by the remote controller at the indoor unit side is possible according to setting at the central controller side. Setting contents 									

Operation from central controller	Operation on remote controller					
	ON/OFF setting	Operation selection	Timer setting	Temp. setting	Fan speed setting	Air direction setting
Individual	○	○	○	○	○	○
[Central 1]	×	○	×	○	○	○
[Central 2]	×	×	×	×	○	○
[Central 3]	○	×	○	×	○	○
[Central 4]	○	×	○	○	○	○

(○: Operation possible ×: Operation impossible)

No.	Item	Outline of specifications	Remarks
19	DC motor	1) When the fan starts, positioning is performed for the starter and the rotor. (Vibrate slightly) 2) DC motor operates according to the command from the indoor controller. (Note) If the fan rotates by entry of outside air, etc while the air conditioner stopped, the indoor unit may operate as the fan motor stops. (Note) If the fan lock was detected, the operation of the indoor unit stops and the check code is displayed.	Check code [P12]
20	Power saving mode	(In the case of RBC-AMT***) 1. Push the  button on the remote controller 2. The “  ” segment lights up on the wired remote controller display. 3. The requirement capacity ratio is limited to approximately 75 %. 4. If the power saving operation is enabled, the settings are retained when the operation is stopped, when the mode is changed, or when the power is reset. The power saving operation will be enabled at the next time the operation starts. • The operation may differ depending on the connected outdoor unit. Refer to the Service Manual of the outdoor unit.	

8. COMMUNICATION TYPE, MODEL NAMES AND THE MAXIMUM NUMBER OF CONNECTABLE UNITS

8-1. This air conditioning (U series) has new communication specifications, and TU2C-Link (U series) and TCC-Link (other than U series) differ in a communication type. For the communication type and the model names such as each unit or remote controllers, refer to the following table.

Communication type	TU2C-Link (U series and future models)	TCC-Link (Other than U series)
Outdoor unit	MMY-M <u>U</u> P*** ↑ This letter indicates U series model.	Other than U series MMY-MAP*** MCY-MHP***
Indoor unit	MM* - <u>U</u> P*** ↑ This letter indicates U series model.	Other than U series MM* -AP***
Wired remote controller	RBC-A** <u>U</u> *** ↑ This letter indicates U series model.	Other than U series
Wireless remote controller kit & receiver unit	RBC-AX <u>U</u> *** ↑ This letter indicates U series model.	Other than U series
Remote sensor	TCB-TC** <u>U</u> *** ↑ This letter indicates U series model.	Other than U series

U series outdoor unit : SMMS-u (MMY-MUP***)
Other than U series outdoor unit : SMMS-i, SMMS-e etc. (MMY-MAP***)

8-2. If TU2C-Link (U series) is combined with TCC-Link (other than U series), the wiring specifications and the maximum number of connectable indoor units during group control operation will be changed.

- (1) For wiring specifications, carry out the installation, maintenance, or repair according to the attached Installation Manual.
- (2) For a communication type combination and the max. number of connectable indoor units, refer to the following table.
 - Only when all outdoor unit, indoor unit and remote control are a U series, communication method is TU2C-LINK, and the maximum number of connectable units will be 16.

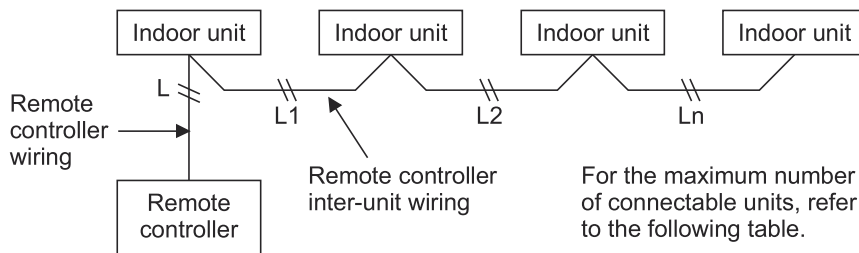

The combination of unit type and the number of the maximum connection of a communication method

	Unit type							
	U series	U series	U series	U series	*	*	*	*
Outdoor unit	U series	U series	U series	U series	*	*	*	*
Indoor unit	U series	U series	*	*	U series	U series	*	*
Remote controller Remote sensor	U series	*	U series	*	U series	*	U series	*
Communication type	TU2C-Link	TCC-Link						
Maximum number of connectable units	16	8						

* Other than U series

9. APPLIED CONTROL AND FUNCTIONS

9-1. Indoor Controller Block Diagram

1. Connection of wired remote controller

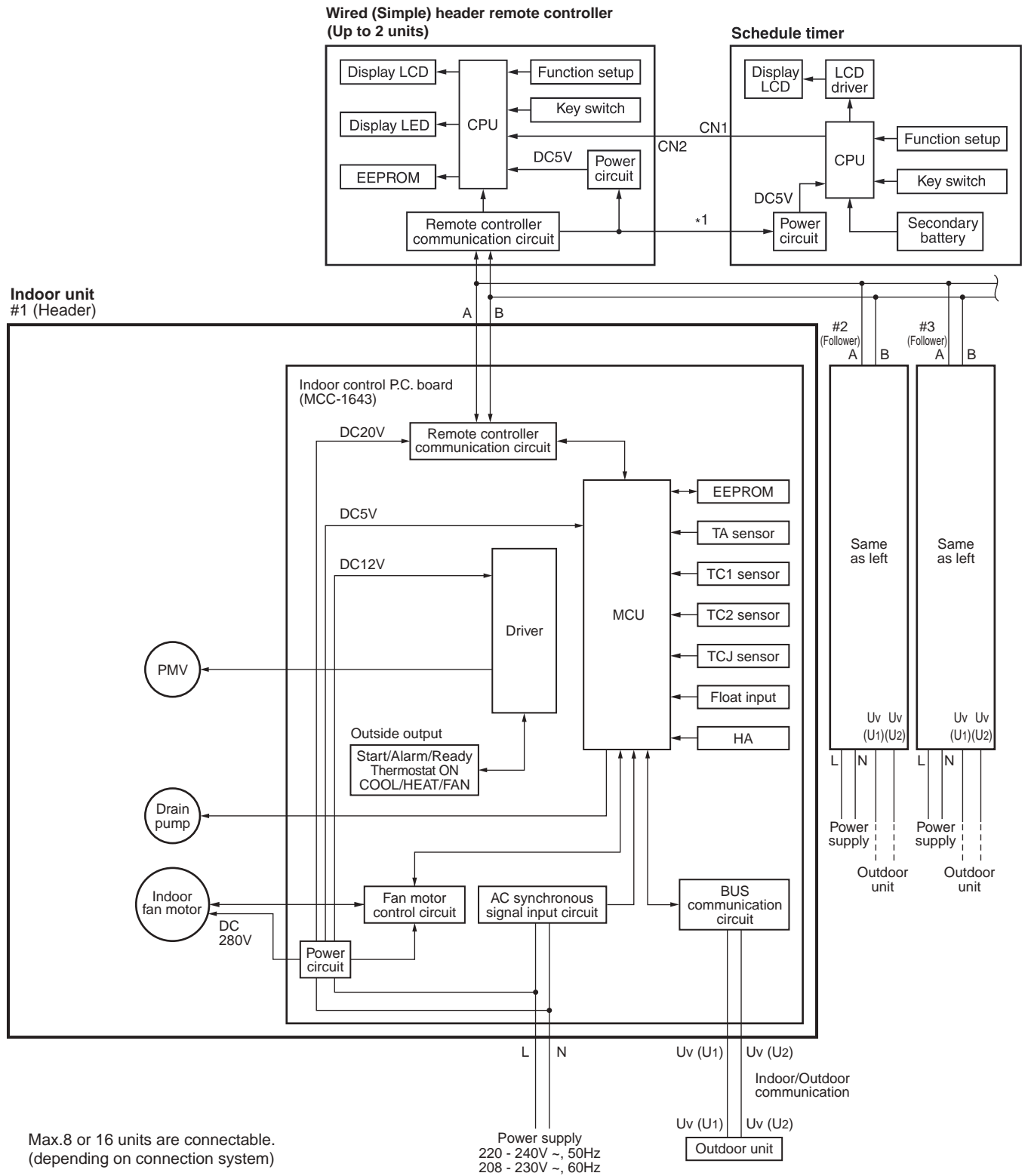

Max.8 or 16 units are connectable.
(depending on connection system)

*1 The schedule timer can be connected
to only RBC-AMT***.

2. Connection of wireless remote controller kit

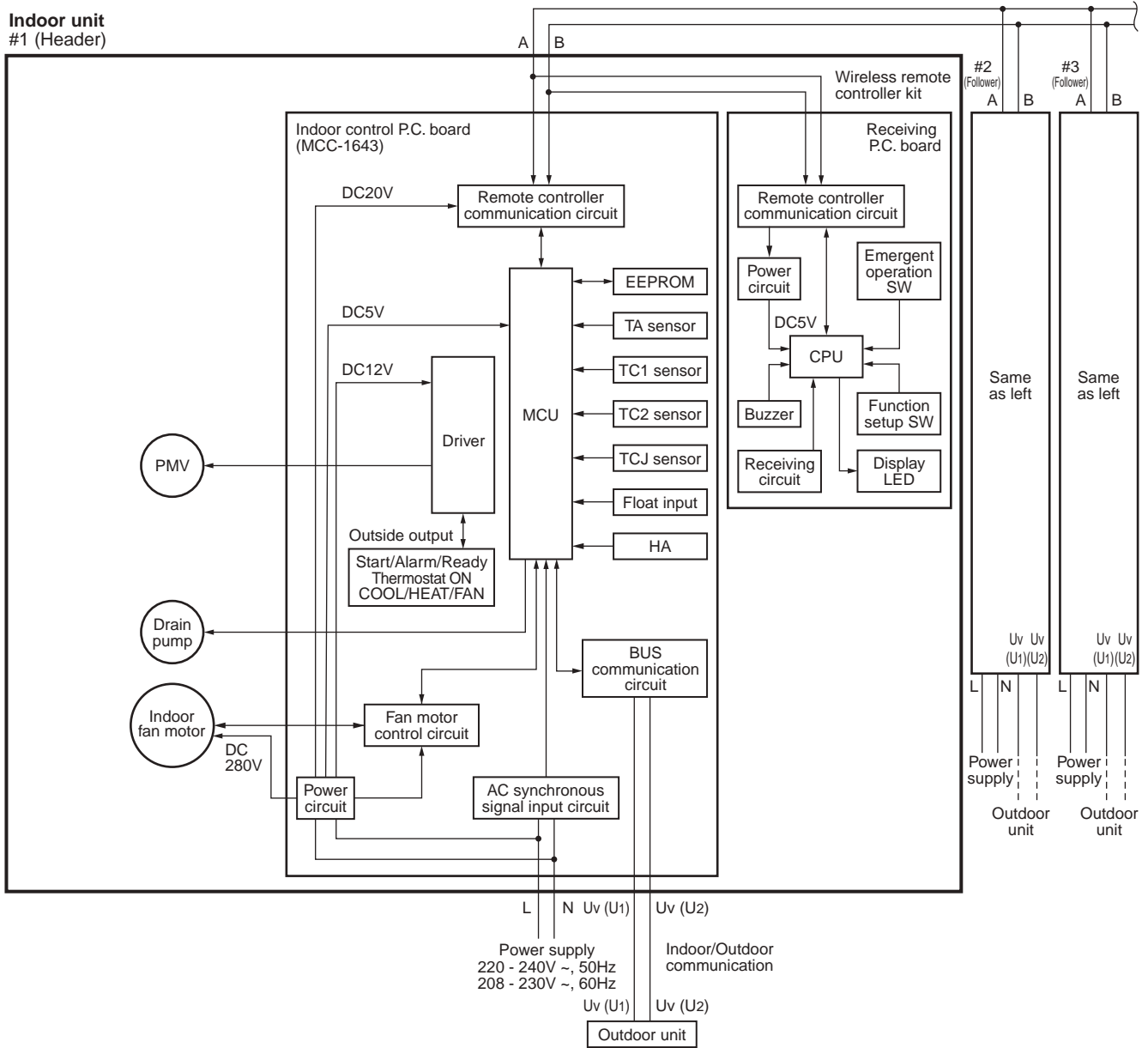

3. Connection of both wired remote controller and wireless remote controller kit

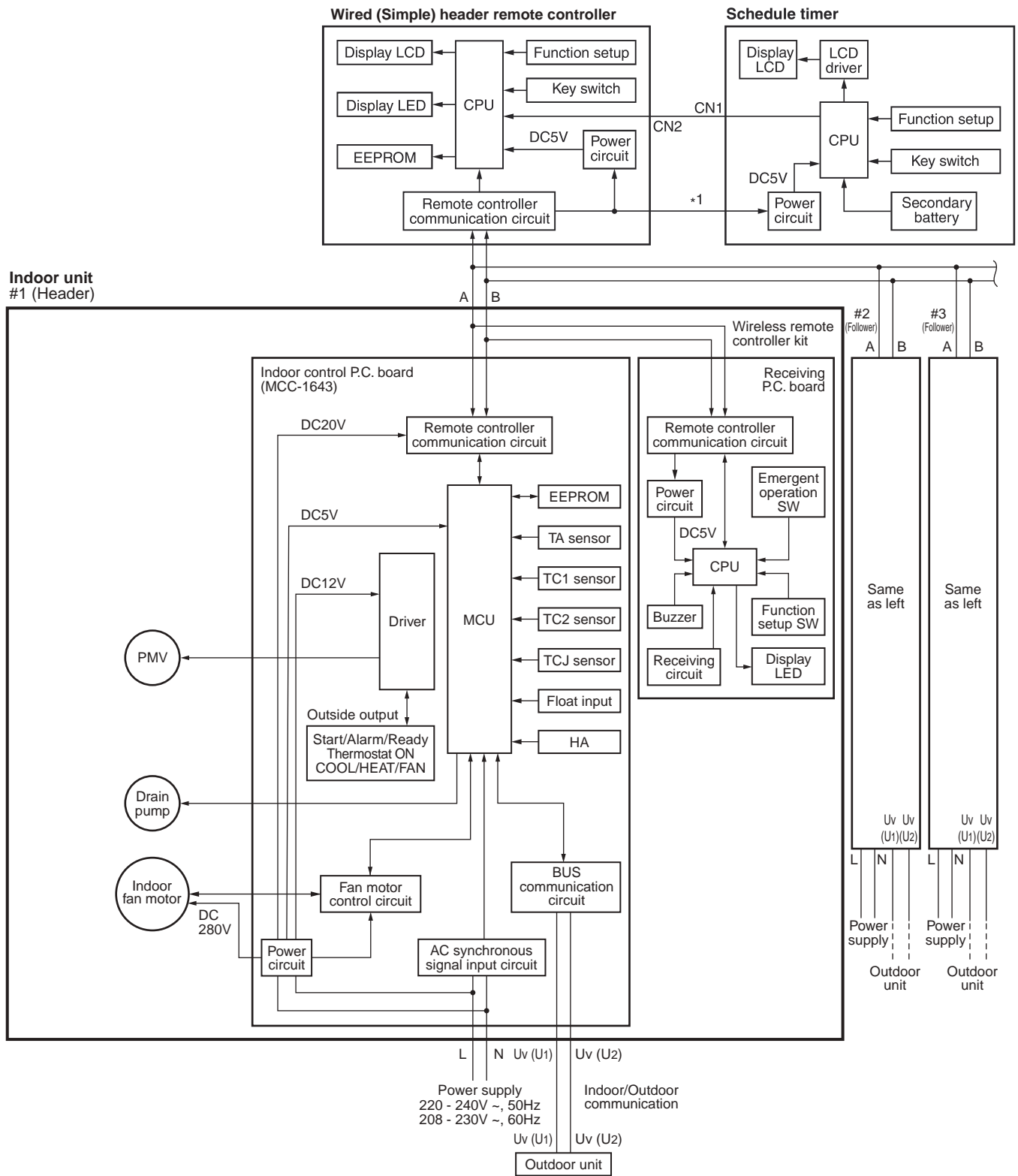

Max.8 or 16 units are connectable.
(depending on connection system)

*1 The schedule timer can be connected to only RBC-AMT***.

9-2. Indoor P.C. board

MCC-1643

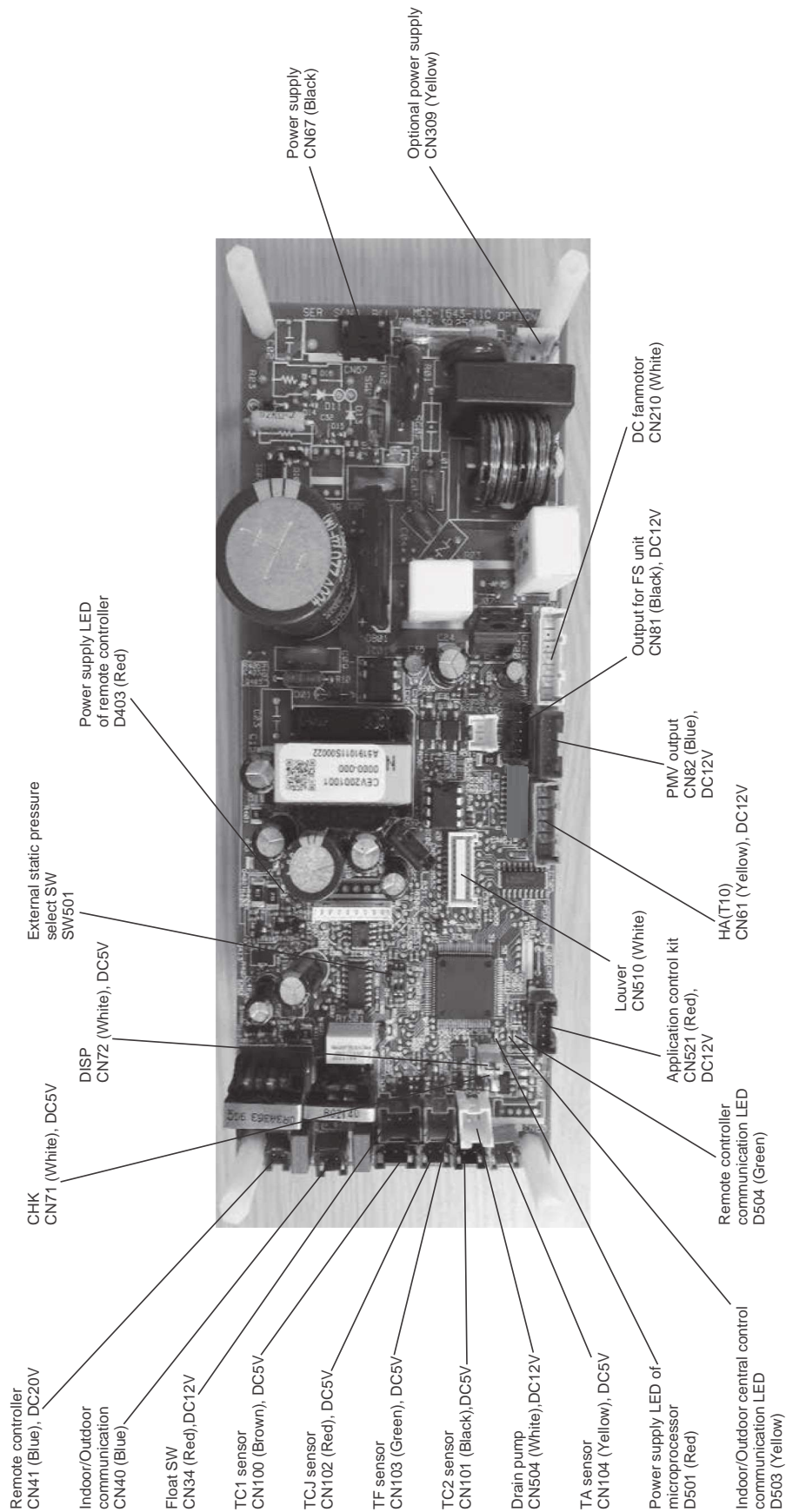

Optional connector specifications of indoor P.C. board (MCC-1643)

Connector No.	Color	Function	Slim Duct	4-way Cassette	Compact 4-way Cassette	2-way Cassette	1-way Cassette (SH)	Floor standing	Pin No.	Specifications	Remarks
CN32	White	Ventilation output	○	○	○	○	○	○	①	DC12V	Setting at shipment: Interlock of ON by indoor unit operation, with OFF by stop operation * The single operation setting by FAN button on the remote controller is performed on the remote controller (DN=31).
CN34	Red	Input for float SW	●	●	●	●	●	✕ (With short-circuit connector)	① ②	DC12V NC	Normal when between ①-③ short-circuits, but abnormal when open-circuits. (check code "P10" appears)
CN61	Yellow	HA	○	○	○	○	○	○	③ ① ② ③ ④ ⑤ ⑥	Float SW input ON/OFF input 0V (COM) Remote controller prohibited input Operation output (Open collector) DC12V (COM) Warning output (Open collector)	HA ON/OFF input (J01: YES/NO=Pulse (At shipment from factory) /Static input selection) Permission/Prohibition of remote controller operation stop is performed by input. Operation ON (Answer back of HA) Warning output ON
CN71	White	CHK Operation check	○	○	○	○	○	○	① ②	Check mode input 0V	This check is used to check indoor operation. (Performs operation of indoor fan "H", Louver horizontal and Drain pump ON without communication with outdoor and remote controller)
CN72	White	DISP Exhibition mode	○	○	○	○	○	○	① ②	DISP mode input 0V	Communication is available by indoor unit and remote controller only (When the power is turned on). Shortening time of timer (Always)
CN81	Black	Output for Flow selector unit	△	△	△	△	△	△	① ② ③ ④ ⑤	DC12V EP valve output (Open collector) Balance valve output (Open collector) Suction valve output (Open collector) Discharge valve output (Open collector)	
CN309	Yellow	Output power supply for option	○	○	○	○	○	○	① ③	AC230V AC230V	This can be used as power supply for option devices.
CN521	Red	Connection for option P.C.board	△	△	△	△	△	△	① ② ③ ④ ⑤	DC12V DC5V Send Receive 0V	Connected Application control kit (TCB-PCUC2E)

● : Use in standard, ○ : Available, △ : Use by connecting parts sold separately, ✕ : Unavailable

* To use the functions operated by CN60, CN80, CN70 and CN73, which are provided for other P.C.board, use the Application control kit (TCB-PCUC2E) sold separately.

9-3. Functions at test run

■ Cooling/Heating test run check

The test run for cooling/heating can be performed from either indoor remote controller or outdoor interface P.C. board. Refer to the Installation Manual and Service Manual of outdoor unit for the procedure of the test run from an outdoor interface P.C. board.

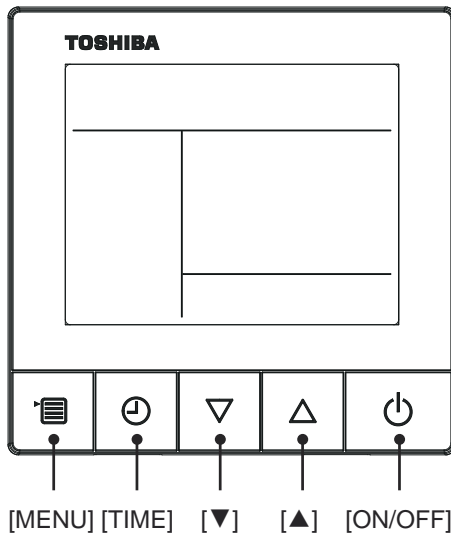

◆ In case of wired remote controller

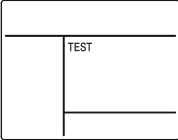
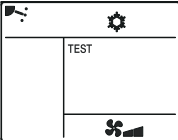
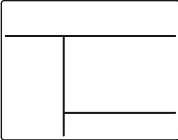

Procedure	Operation contents	
<p>1</p>	<p>Push [TIME] and [▲] buttons and hold for more than 10 seconds. If [TEST] is displayed on screen, it shows that the system is currently in test run mode.</p>	
<p>2</p>	<p>Push [ON/OFF] button to start the air conditioner.</p>	
<p>3</p>	<p>Using [MENU] button to change the cooling or heating mode</p> <ul style="list-style-type: none"> • Do not use [MENU] button to change modes other than cooling and heating modes. • Under heating and cooling operations, a command for fixing test running frequency will be output. • The temperature cannot be adjusted during the test run, but the fan speed can be selected. • Fault detection is operating normally, but do not use this function in "test run" as this will cause load on the equipment. 	
<p>4</p>	<p>Push [ON/OFF] button to stop the operation after the test run.</p>	
<p>5</p>	<p>Push [TIME] button to clear the TEST mode, [TEST] display in the display part disappears and the status returns to the normal stop status. (To prevent a continuous test run operation, the remote controller will be shut off automatically after 60 minutes.)</p>	

◆ **In case of wireless remote controller**

1 Turn on the power of the air conditioner.
 When power is turned on for the first time after installation, it takes approx. 5 minutes until the remote controller becomes available. In the case of subsequent power-on, it takes approx. 1 minute until the remote controller becomes available.
 Execute a test run after the predetermined time has passed.

2 Push “ON/OFF” button on the remote controller, select [ Cool] or [ Heat] with “MODE” button, and then select [ HIGH] with “FAN” button.

3

Cooling test run	Heating test run
Set the temperature to 17 °C with the temp. setup buttons.	Set the temperature to 30 °C with the temp. setup buttons.

4

Cooling test run	Heating test run
After confirming a signal receiving sound “beep” immediately set the temperature to 18 °C with the temp. setup buttons.	After confirming a signal receiving sound “beep” immediately set the temperature to 29 °C with the temp. setup buttons.

5

Cooling test run	Heating test run
After confirming a signal receiving sound “beep” immediately set the temperature to 17 °C with the temp. setup buttons.	After confirming a signal receiving sound “beep” immediately set the temperature to 30 °C with the temp. setup buttons.

6 Repeat procedures **4 → 5 → 4 → 5**.
 Indicators “Operation” (green), “Timer” (green), and “Ready” (orange) in the wireless receiver section flash in approx. 10 seconds, and the air conditioner starts operation. If any of these indicators does not flash, repeat procedures 2 to 5.

7 Upon completion of the test run, push “ON/OFF” button to stop operation.

<Overview of test run operations using the wireless remote controller>

▼ Cooling test run:
 ON/OFF → 17 °C → 18 °C → 17 °C → 18 °C → 17 °C → 18 °C → 17 °C → (test run) → ON/OFF

▼ Heating test run:
 ON/OFF → 30 °C → 29 °C → 30 °C → 29 °C → 30 °C → 29 °C → 30 °C → (test run) → ON/OFF

■ Check function for operation of indoor unit (Functions at indoor unit side)

This function is provided to check the operation of the indoor unit individually without connecting to the remote controller or the outdoor unit. This function can be used regardless of the ON/OFF operation.

However, it is recommend to avoid using this function for along time, otherwise the trouble of the equipment may occurred.

[How to operate]

- 1) Short-circuit CHK pin (CN71 on the indoor P.C. board).
The operation mode may differ according to the indoor unit status at that time.
Normal time: Both float SW and fan motor are normal.
Abnormal time: Either one of float SW or fan motor is abnormal.
- 2) During the normal time, the minimum opening degree (30pls) of the indoor PMV can be set only when both CHK pin (CN71) and DISP pin (CN72) on the indoor P.C board are short-circuited. If the short-circuit at DISP pin (CN72) is opened, the indoor PMV will be at the maximum opening degree (1500pls).

[How to clear]

Open CHK pin.If the system is on operation, it will temporarily stop then automatically restart after a while.

	Short-circuit of CHK pin		
	Normal time		Abnormal time
	DISP pin open	DISP pin short circuit	
Fan motor	(H)	(H)	Stop
Indoor PMV (*)	Max. opening degree (1500pls)	Min. opening degree (30pls)	Min. opening degree (30pls)
※Drain pump	ON	ON	ON
Communication	All ignored	All ignored	All ignored
P.C. board LED	Lights	Lights	Flashes

- To exchange the indoor PMV coil, set the indoor PMV to Max. opening degree.
- For the detailed positions of CHK pin (CN71 on indoor P.C. board) and DISP pin (CN72 on indoor P.C. board), refer to the indoor P.C. board MCC-1643.

9-4. Setup of Selecting Function in Indoor Unit (Be Sure to Execute Setup by a Wired Remote Controller)

<Procedure> Execute the setup operation while the unit stops.

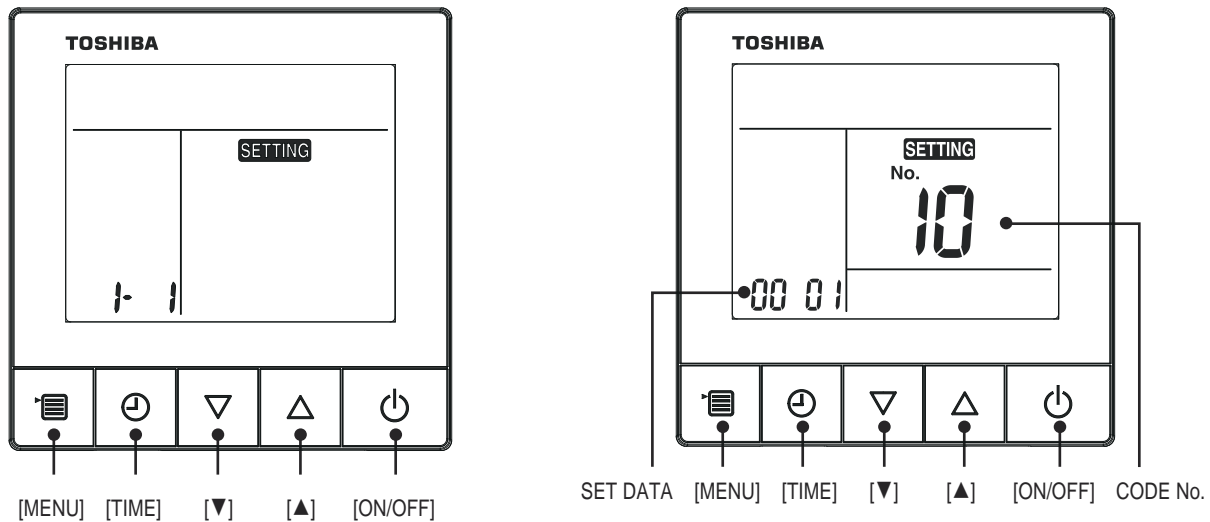

- 1** In STOP status push [MENU] and [▼] buttons simultaneously for at least 10 seconds.
 - In the air-conditioning group control mode, **SETTING** and the indoor unit No.1-N are displayed first. 1 is the piping system address (the value of the refrigerant piping system is the same as the number of outdoor units, and one outdoor unit is displayed as 1). The indoor unit address represented by N is the main indoor unit address.
 - In the non-group control mode (only one indoor unit), only 1-1 is displayed on the left.
- 2** Push [▼] or [▲] button to adjust the indoor unit number. The indoor unit number in the group control will be changed cyclically. Select an indoor unit to change the settings and push [TIME] button to confirm.
The fan of the selected indoor unit starts its operation and the swing operation of the louvers starts after confirmation.
- 3** Using [▼] or [▲] button, select the CODE No. [**] to be set.
- 4** Use [MENU] button to adjust the flash from CODE No. to SET DATA on the left. Select the specified SET DATA [****] as required.
(Set the SET DATA of CODE No. [33] from [0000] to [0001], and change the unit of the temperature on the remote controller from “°C” to “°F”.)
- 5** Push [MENU] button to adjust the flash to CODE No. on the right after pushing [TIME] button to confirm.
 - To change the settings of another indoor unit, push [ON/OFF] button to close the current setting, and repeat from step **1**.
 - To change other settings of the indoor unit, repeat from step **3**.
- 6** Push [ON/OFF] button to complete the setting when the setting is completed.
When [ON/OFF] button is pushed, **SETTING** flashes, then the display disappears and the air conditioner enters the normal stop mode.
(When **SETTING** flashes, it cannot receive operation instructions from the remote controller.)

Indoor unit function Code No. (DN Code) table

(includes functions needed to perform applied control on site)

DN	Item	Description	At shipment
01	Filter display delay timer	0000: None 0001: 150H 0002: 2500H 0003: 5000H 0004: 10000H	Depending on model type
02	Dirty state of filter	0000: Standard 0001: High degree of dirt (Half of standard time)	0000: Standard
03	Central control address	0001: No.1 unit to 0064: No.64 unit ... TCC-LINK 0001: No.1 unit to 0128: No.128 unit ... TU2C-LINK 00Un: Unfixed (When using U series remote controller) 0099: Unfixed (Other than U series remote controller)	00Un/0099: Unfixed *1
04	Specific indoor unit priority	0000: No priority 0001: Priority	0000: No priority
06	Heating temp. shift	0000: 0 °C 0002: +2 °C to 0001: +1 °C 0010: +10 °C (Up to +6 recommended)	Depending on model type
0b	Demand control (CN73 / CN4)	0000: Demand input 0001: O2 sensor input 0002: Card input setup.3 0003: Fire alarm input (Normal open) 0004: Card input setup.4 0005: Fire alarm input (Normal close) 0006: Notice code (202) 0007: Card input setup.5 0008: Card input setup.1 0009: Card input setup.2	0000: Demand input
0d	Existence of [AUTO] mode	0000: Provided 0001: Not provided (Automatic selection from connected outdoor unit)	0001: Not provided
0F	Cooling only	0000: Heat pump 0001: Cooling only (No display of [AUTO] [HEAT])	0000: Heat pump
10	Type		
11	Indoor unit capacity	0000: Unfixed 0001 to 0044	According to capacity type
12	Line address	0001: No.1 unit to 0064: No.30 unit ... TCC-LINK 0001: No.1 unit to 0128: No.128 unit ... TU2C-LINK 00Un: Unfixed (When using U series remote controller) 0099: Unfixed (Other than U series remote controller)	00Un/0099: Unfixed *1
13	Indoor unit address	0001: No.1 unit to 0064: No.64 unit ... TCC-LINK 0001: No.1 unit to 0128: No.128 unit ... TU2C-LINK 00Un: Unfixed (When using U series remote controller) 0099: Unfixed (Other than U series remote controller)	00Un/0099: Unfixed *1
14	Group address	0000: Individual 0001: Header unit of group 0002: Follower unit of group 00Un: Unfixed (When using U series remote controller) 0099: Unfixed (Other than U series remote controller)	00Un/0099: Unfixed *1
1E	Temp difference of [AUTO] mode selection COOL → HEAT, HEAT → COOL	0000: 0 °C to 0010: 10 °C (Ts ± 5°C) Ts:Remote controller setup temp.	0003: 3 °C (Ts ±1.5 °C)
28	Automatic restart of power failure	0000: None 0001: Restart	0000: None
2A	Selection of option/Trouble input (TCB-PCUC2E: CN3)	0000: Filter input 0001: Alarm input (Air washer, etc.) 0002: None	0002: None
2E	HA terminal (CN61) select	0000: Usual 0001: Card input setup.1 (3) 0002: Fire alarm input (Normal open) 0003: Card input setup.2 (4) 0004: Notice code (201) 0005: Card input setup.5	0000: Usual (HA terminal)
31	Ventilating fan control	0000: Unavailable 0001: Available	0000: Unavailable
32	TA sensor selection	0000: Indoor unit TA sensor 0001: Remote controller sensor	0000: Indoor unit TA sensor

DN	Item	Description	At shipment												
33	Temperature unit select	0000: °C 0001: °F	0000: °C												
5d	External static pressure	<table border="1"> <tr> <td>Set data</td> <td>0000</td> <td>0001</td> <td>0003</td> <td>0004</td> <td>0006</td> </tr> <tr> <td>External static pressure</td> <td>10Pa (Factory setting)</td> <td>20Pa</td> <td>30Pa</td> <td>40Pa</td> <td>50Pa</td> </tr> </table>	Set data	0000	0001	0003	0004	0006	External static pressure	10Pa (Factory setting)	20Pa	30Pa	40Pa	50Pa	0000: Standard
		Set data	0000	0001	0003	0004	0006								
External static pressure	10Pa (Factory setting)	20Pa	30Pa	40Pa	50Pa										
The list above is when SW501-1 and SW501-2 is OFF.															
60	Timer setting (wired remote controller)	0000: Available (can be performed) 0001: Unavailable (cannot be performed)	0000: Available												
77	Dual set point	0000: Unavailable 0002: Available	0000: Unavailable												
79	Alarm output setup of the header unit	0000: Not including the state of following unit 0001: Including the state of following unit	0000: Not including the state of following unit												
b3	Soft cooling	0000: Unavailable 0001: Available	0001: Available												
d0	Whether the power saving mode can be set by the remote controller	0000: Invalid 0001: Valid	0001: Valid												
E0	Destination	0000: Japan 0004: Global	0004: Global												
E6	Wireless remote controller A-B selection	0000: A 0001: B	0000: A												
F6	Presence of Application control kit (TCB-PCUC2E)	0000: None 0001: Exist	0000: None												
FC	Communication protocol *2	0000: TCC-LINK 0003: TU2C-LINK	0000: TCC-LINK												
Fd	Priority operation mode (FS unit)	0000: Heating 0001: Cooling	0000: Heating												
FE	FS unit address	0001: No.1 unit to 0064: No.64 unit ... TCC-LINK 0001: No.1 unit to 0128: No.128 unit ... TU2C-LINK 00Un: Unfixed (When using U series remote controller) 0099: Unfixed (Other than U series remote controller)	00Un/0099: Unfixed *1												
180	Notice code number 01	0000: None 0001 ~ 0255: Notice code 0129: Notice code (201) 0130: Notice code (202) (0001 ~ 0255: TU2C-LINK only)	0000: None												
181	Notice code number 02		0000: None												
182	Notice code number 03		0000: None												
183	Notice code number 04		0000: None												
184	Notice code number 05		0000: None												
185	Notice code number 06		0000: None												
186	Notice code number 07		0000: None												
187	Notice code number 08		0000: None												
188	Notice code number 09		0000: None												
189	number 10		0000: None												
103	Remote controller	0000: Use 0001: Do not use	0000: Use												
1FB	Central device control state	0000: No central device control (Remote controller use is possible) 0001: Central device control (Remote controller use is impossible)	0000: No central device control												
1FC	Indoor Unit terminating resistance	0000: OFF 0001: ON	0000: OFF												

*1 Display order of "00Un" and "0099" varies depending on remote controller models or communication types.

For Central control address (DN [03]), Indoor unit address (DN [13]), FS unit address (DN [FE])

Remote controller	Communication type	Display order
U series	TU2C-LINK	... ⇔ 0128 ⇔ 00Un ⇔ 0001 ⇔ ...
	TCC-LINK	... ⇔ 0064 ⇔ 00Un ⇔ 0001 ⇔ ...
Other than U series	TCC-LINK	... ⇔ 0064 ⇔ 0099 ⇔ 0001 ⇔ ...

For Line address (DN [12])

Remote controller	Communication type	Display order
U series	TU2C-LINK	... ⇔ 0128 ⇔ 00Un ⇔ 0001 ⇔ ...
	TCC-LINK	... ⇔ 0030 ⇔ 00Un ⇔ 0001 ⇔ ...
Other than U series	TCC-LINK	... ⇔ 0030 ⇔ 0099 ⇔ 0001 ⇔ ...

For Group address (DN [14])

Remote controller	Communication type	Display order
U series	TU2C-LINK	... ⇔ 0002 ⇔ 00Un ⇔ 0000 ⇔ ...
	TCC-LINK	
Other than U series	TCC-LINK	... ⇔ 0002 ⇔ 0099 ⇔ 0000 ⇔ ...

*2 Communication protocol can be automatically switched with the setup in the outdoor unit during installation.

TYPE

Setup data	Type	Abbreviated Model name
0015	Slim duct type	MMD-UP***1SPHY*

Indoor unit capacity

CODE No. [11]

0044	003 type
0041	005 type
0001	007 type
0003	009 type
0005	012 type
0007	015 type
0009	018 type
0011	024 type
0012	027 type

9-5. Applied Control in Indoor Unit

■ Remote location ON/OFF control box (TCB-IFCB-4E2)

[Wiring and setup]

In the case of group control, the control system functions as long as it is connected to one of the indoor units (control P.C. board) in the group. If it is desired to access the operation and trouble statuses of other units, relevant signals must be brought to it from those units individually.

1. Control items

- 1) Start/Stop input signal : Operation start/stop in unit
- 2) Operation signal : Output during normal operation
- 3) Check code Output : Output during alarm
(Serial communication trouble or indoor/outdoor protective device) operation

2. Wiring diagram using remote control interface (TCB-IFCB-4E2)

Input IFCB-4E2 : No voltage ON/OFF serial signal
 Output No voltage contact for operation, check code display
 Contact capacity: Below Max. 240V 0.5A

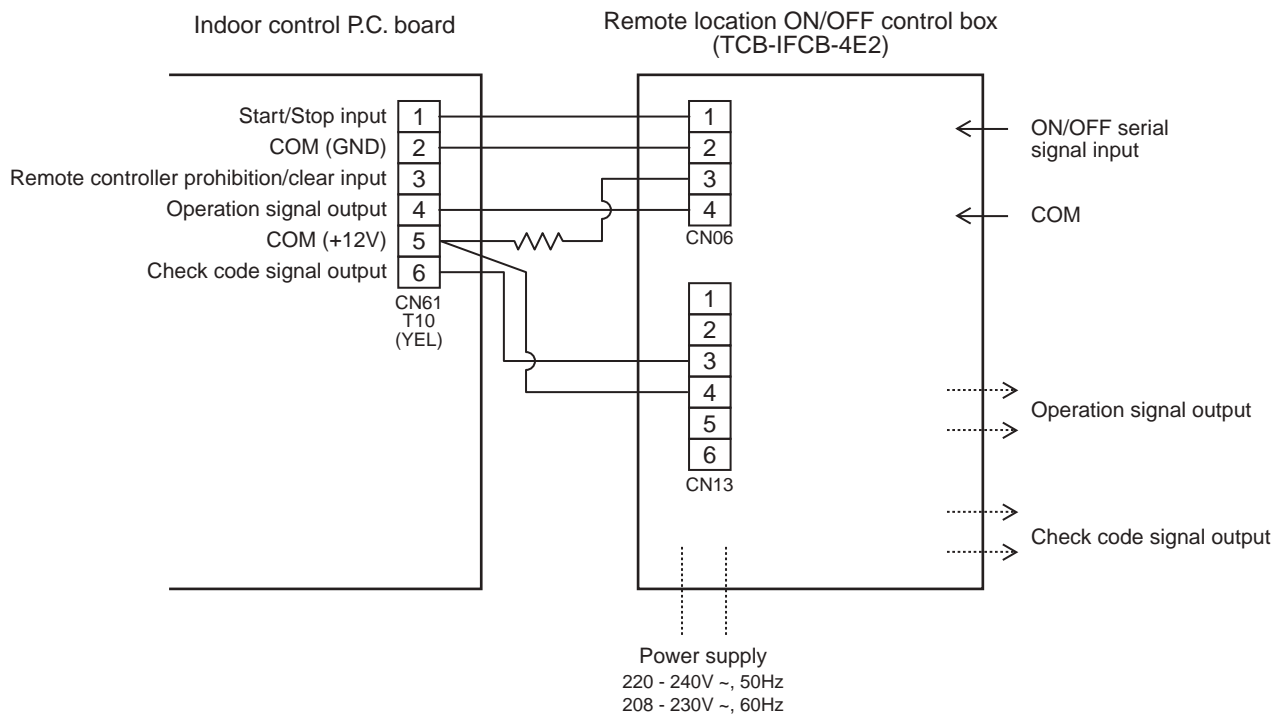

■ Ventilating fan control from remote controller

[Function]

- The start/stop operation can be operated from the wired remote controller when air to air heat exchanger or ventilating fan is installed in the system.
- The fan can be operated even if the indoor unit is not operating.
- Use a fan which can receive the no-voltage normally-open contact as an outside input signal.
- In a group control, the units are collectively operated and they can not be individually operated.

1. Operation

Handle a wired remote controller in the following procedure.

- * Use the wired remote controller during stop of the system.
- * Be sure to set up the wired remote controller to the header unit. (Same in group control)
- * In a group control, if the wired remote controller is set up to the header unit, both header and follower units are simultaneously operable.

1 Push [MENU] and [▼] buttons simultaneously for at least 10 seconds.

- In the air-conditioning group control mode, **SETTING** and the indoor unit No. are displayed. The indoor unit number displayed first is the main indoor unit number.
- In the non-group control mode (only one indoor unit), only 1-1 is displayed on the left.

2 Push [▼] or [▲] button to adjust the indoor unit number. The indoor unit number in the group control will be changed cyclically. Select an indoor unit to change the settings and push [TIME] button to confirm.

The fan of the selected indoor unit starts its operation and the swing operation of the louvers starts after confirmation.

3 Using [▼] or [▲] button, set the CODE No. to [31].

4 Use [MENU] button to adjust the flash from CODE No. to SET DATA on the left. Use [▼] or [▲] button to select the selected SET DATA. (factory default: 0000)

The setting data is as follows:

Setup data	Handling of operation of air to air heat exchanger or ventilating fan
0000	Unavailable (At shipment)
0001	Available

5 Push [MENU] button to adjust the flash to CODE No. on the right after pushing [TIME] button to confirm.

- To change the settings of another indoor unit, push [ON/OFF] button to close the current setting, and repeat from step **1**.
- To change other settings of the indoor unit, repeat from step **3**.

6 Push [ON/OFF] button to complete the setting when the setting is completed.

2. Wiring

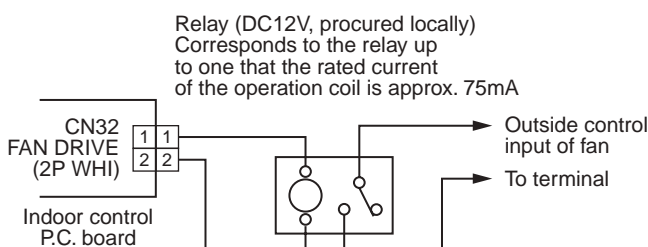

Note) Determine the cable length between the indoor control P.C. board and the relay within 2m.

■ Auto-off feature control

[Function]

- This function controls the indoor units individually. It is used when the start operation from outside is unnecessary but the stop operation is necessary.
 - A card switch box or card lock helps protect customers from forgetting to turn off the indoor unit. (not including the following Card Input 3)
 - It is connected with connector on the indoor control P.C. board, and switched with the Code No. and jumper wire setup for use.
 - Available connectors are CN61 or CN73. For models without CN73, CN4 on the optional Application control kit (TCB-PCUC2E) can be used.
- * Leaving-ON prevention control cannot be set with both CN61 and CN73 (CN4).
If both of them are set, CN73 (CN4) setting automatically turns to a factory default.

[Setup method]

(1) Wiring

Connecting to the CN61 connector

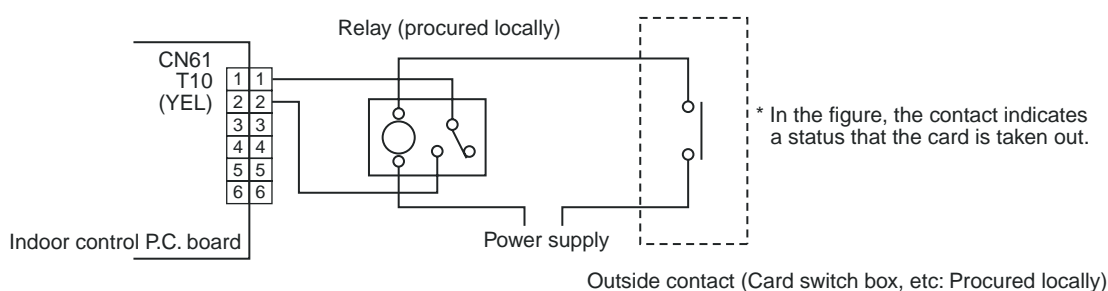

NOTE) Determine the cable length between the indoor control P.C. board and the relay within 3m.

Connecting to the Application control kit (TCB-PCUC2E, connector : CN4)

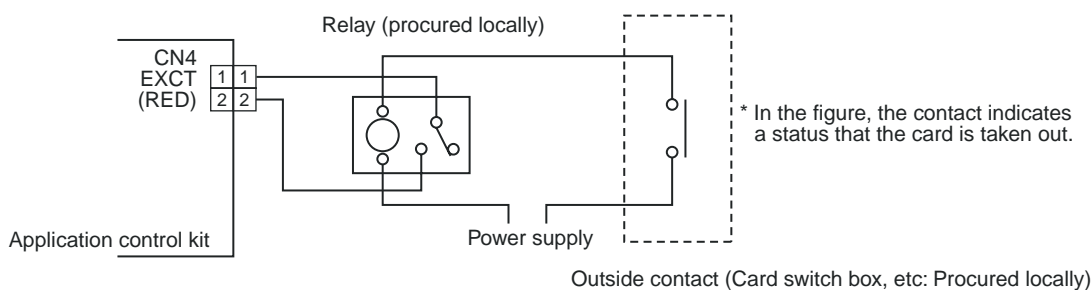

NOTE) Determine the cable length between the indoor control P.C. board and the relay within 3m.

(2) Code (DN) setup

Set Code (DN) according to "9-5. Method to set indoor unit function DN code".

Connector	Jumper wire (J01)	Code No. (DN)	Set data	Function
CN61	Short-circuit (Factory default)	002E	0000 (Factory default)	"HA normal setup" (pulse)
			0001	"Card Input 1" setup
			0003	"Card Input 2" setup
	Open-circuit (cut)		0005	"Card Input 5" setup
			0000 (Factory default)	"HA normal setup" (Static)
			0001	"Card Input 3" setup
CN73 (CN4)	Short-circuit (Factory default) or Open-circuit (cut)	000b	0003	"Card Input 4" setup
			0000 (Factory default)	"EXCT demand" setup (Forced thermostat-OFF)
			0002	"Card Input 3" setup
			0004	"Card Input 4" setup
			0007	"Card Input 5" setup
			0008	"Card Input 1" setup
0009	"Card Input 2" setup			

* If you set "Card Input 1 to 5" for Code No. of CN61 and CN73, Code No. 000b setup becomes unavailable and the functions of Card Input 1 to 5 in CN73 cannot be used.

[Control items]

Function	External contact terminal	
	Close (Status that card is inserted)	Open (Status that card is taken out)
Card Input 1	Manual prohibition release (Manual operation)	Manual prohibition (Operation stop)
Card Input 2	Manual prohibition release (Automatic operation)	Manual prohibition (Operation stop)
Card Input 3	Operation status continues (Do nothing)	Operation status continues and setting temperature changes (COOL/DRY: 29°C, HEAT: 18°C)
Card Input 4	Manual prohibition release (The status returns to operating condition before removing the card.)	Manual prohibition (Operation stop)
Card Input 5	1) To change a setting temperature by changing data at DN code No. 172 to 174. 2) The operation mode can be set by changing data (0000, 0001, 0002) at DN code No. 16b. 0000: operation mode is the same at the current mode. (factory setting default) 0001: operation mode returns to the previous mode when card was inserted. (in case of the previous mode is off operation, the operation mode is also off.) 0002: operation mode starts at the same previous mode when the card was inserted. (the operation mode is on operation even the previous mode is off operation.) See contents below for DN settings and detailed operations.	1) To change a setting temperature, fan speed and wind direction by changing data at DN code No. 16C to 171. 2) The operation mode can be set by changing data (0000, 0001) at DN code No. 16A. 0000: operation mode is the same at the current mode. (factory setting default) 0001: operation automatically starts. See contents below for DN settings and detailed operations.

* For the card switch box that does not involve contact operation described above, convert signals with a relay including a normally-closed contact.

[Card input setup.5 Code (DN)]

DN	Item	Description	At shipment
16C	Open mode Set temp. (Cool, Dry)	-0015 : -15°C to 0060 : 60°C	0027 : 27°C
16d	Open mode Set temp. (Heat)	-0015 : -15°C to 0060 : 60°C	0020 : 20°C
16E	Open mode Set temp. (Auto)	-0015 : -15°C to 0060 : 60°C	0024 : 24°C
16F	Open mode Fan speed (All operation mode)	0000 : No change 0001 : HH 0002 : H 0003 : L	0000 : No change
170	Open mode Wind direction (Cool, Dry, Fan)	0000 : No change 0001 : F1 0002 : F2 0003 : F3	0000 : No change
171	Open mode Wind direction (Heat)	0000 : No change 0001 : F1 0002 : F2 0003 : F3 0004 : F4 0005 : F5	0000 : No change
16A	Open mode Operation	0000 : No change 0001 : Run operation	0000 : No change
172	Close mode Set temp. (Cool, Dry)	-0015 : -15°C to 0060 : 60°C	0024 : 24°C
173	Close mode Set temp. (Heat)	-0015 : -15°C to 0060 : 60°C	0024 : 24°C
174	Close mode Set temp. (Auto)	-0015 : -15°C to 0060 : 60°C	0024 : 24°C
16b	Close mode Operation	0000 : No change 0001 : Card ON mode operation 0002 : Run operation (Card ON mode setting)	0000 : No change

[The example of Card Input 5 setting]

Case.	Code No. (DN) setting									External contact terminal	
	[16A] data	[16b] data	[16C] data	[16d] data	[16F] data	[170] data	[171] data	[172] data	[173] data	Close (Status that card is inserted)	Open (Status that card is taken n out)
(1)	0000	0000	0027	0020	0000	0000	0000	0024	0024	- The operation mode continues running at the same as the current mode. - The setting temperature of cooling/dry and heating mode is changed to 24°C and 24°C respectively due to change in code No. 172, 173.	- The operation mode continues running at the same as the current mode. - the setting temperature of cooling/dry and heating mode is changed to 27°C and 20°C respectively due to change in code No. 16C, 16d.
(2)*	0000	0001	0027	0020	0003	0001	0001	0024	0024	- The operation mode is running at the same mode as the last time when the card was inserted due to change in code no. 16b. * The operation mode will be off if the mode at the last time was in off operation. Also, the fan speed will be the same as the last time when the card was inserted. - The setting temperature of cooling/dry and heating mode is changed to 24°C and 24°C respectively due to change in code No. 172, 173.	- The operation mode continues running at the same as the current mode. - The setting temperature of cooling/dry and heating mode is changed to 27°C and 20°C respectively due to change in code no. 172, 173. - The fan speed for all operation modes is changed due to change in code no.16F. - The wind direction of Cooling/dry/fan and heating mode are changed due to change in code No. 170, 171 respectively.
(3)*	0000	0002	0027	0020	0003	0001	0001	0024	0024	- The operation mode is running at the same mode as the last time when the card was inserted. Also, the operation mode will be on even the mode was in off operation at the last time due to change in code no. 16B. * The fan speed will be the same as the last time when the card is inserted. - The setting temperature of cooling/dry and heating mode is changed to 24°C and 24°C respectively due to change in code No. 172, 173.	Same operation as case (2)
(4)	0001	0000	0027	0020	0003	0001	0001	0024	0024	- The operation mode continues running at the same as the current mode. - The setting temperature of cooling/dry and heating mode is changed to 24°C and 24°C respectively due to change in code No. 172, 173.	- Due to change in code no. 16A, the operation mode will be as below. •when the operation is ON, the operation mode will continue running at the same as the current mode. •when the operation is OFF, the air conditioner will turn on automatically. - The setting temperature of cooling/dry and heating mode is changed to 27°C and 20°C respectively due to change in code No. 172, 173. - The fan speed for all operation modes is changed due to change in code no.16F. - The wind direction of Cooling/dry/fan and heating mode are changed due to change in code No. 170, 171 respectively.

* The history operation mode is only recorded when the card is inserted even if the operation mode is changed when the card is taken out, there is no related to the history operation mode.

■ Power peak-cut from indoor unit

When the relay is turned on, a forced thermostat OFF operation starts.

- For indoor P.C. boards other than MCC-1643, the “EXCT” is input with connector CN73 on the P.C. board. MCC-1643 requires Application control kit (TCB-PCUC2E) for input of a forced thermostat OFF “EXCT”. Please refer to the manual of Application control kit for a detailed setting.

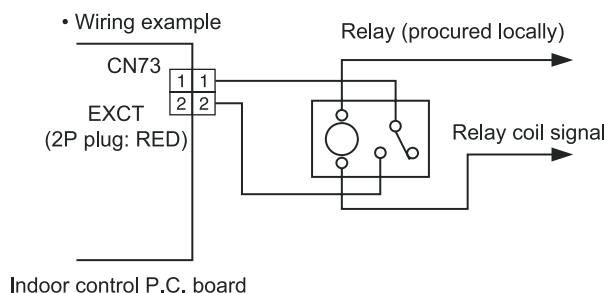

Note) Determine the cable length between the indoor or outdoor control P.C. board and the relay within 2 m.

■ Address setup (Manual setting from remote controller)

In case that addresses of the indoor units will be determined prior to piping work after cabling work

- Set an indoor unit per a remote controller.
- Turn on power supply.

- 1** Push [MENU] and [▼] buttons simultaneously for at least 10 seconds.
- 2** Push [▼] or [▲] button to adjust the indoor unit number, and push [TIME] button to confirm.

Line address settings:

- 3** Using [▼] or [▲] button, set the CODE No. to [12].
- 4** Use [MENU] button to adjust the flash from CODE No. to SET DATA on the left. Use [▼] or [▲] button to set the line address.

- 5** Push [MENU] button to adjust the flash to CODE No. on the right after pushing [TIME] button to confirm.

Setting of indoor unit address:

- 6** Using [▼] or [▲] button, set the CODE No. to [13].
- 7** Use [MENU] button to adjust the flash from CODE No. to SET DATA on the left. Use [▼] or [▲] button to set the address of the indoor unit.
- 8** Push [MENU] button to adjust the flash to CODE No. on the right after pushing [TIME] button to confirm.

Setting of group address:

- 9** Using [▼] or [▲] button, set the CODE No. to [14].
- 10** Use [MENU] button to adjust the flash from CODE No. to SET DATA on the left. Set 0000 as a standalone unit, set 0001 as a main unit, set 0002 as a sub unit.
- 11** Push [MENU] button to adjust the flash to CODE No. on the right after pushing [TIME] button to confirm.
- 12** Push [ON/OFF] button to complete the setting when the setting is completed.

- To change the settings of another indoor unit, repeat from step **1**.
- Repeat steps **1** to **9** until all indoor unit addresses are set and with no duplication.

Note 1)

When setting the line address from the remote controller, do not use Address 29 and 30.

As they are addresses which cannot be set to the outdoor unit, if they are set, the check code [E04] (Indoor/Outdoor communication circuit trouble) is issued.

Note 2)

When an address was manually set from the remote controller and the central control over the refrigerant lines is carried out, perform the following setting for the Master unit of each line.

- Set the line address for every line using SW13 and 14 on the interface P.C. board of the center unit in each line.
- Except the least line address No., turn off SW2-30 on the interface P.C. board of the Master units in the lines connected to the identical central control.
(Draw the terminal resistances of indoor/outdoor and central control line wirings together.)
- For each refrigerant line, connect the relay connector between Master unit [U1U2] and [U3U4] terminals.
- After then set the central control address.
(For setting of the central control address, refer to the Installation manual for the central control equipment.)

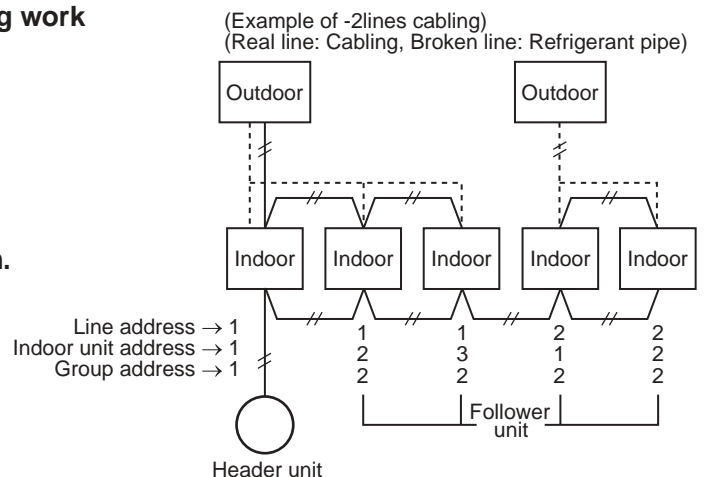

For the above example, perform setting by connecting singly the wired remote controller without remote controller inter-unit cable.

Group address
Individual : 0000
Header unit : 0001
Follower unit : 0002 } In case of group control

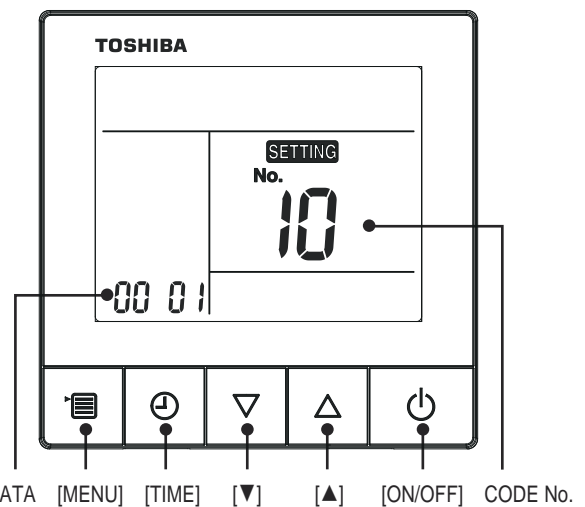

■ Confirmation of indoor unit No. position

1. To know the indoor unit addresses though position of the indoor unit is recognized

- In case of individual operation (Wired remote controller : indoor unit = 1 : 1)
(Follow to the procedure during operation)

<Procedure>

1 When the indoor unit is stopped, push [MENU] and [▼] buttons simultaneously for at least 10 seconds.

- After entering, the screen displays **SETTING** and the indoor unit number. The indoor unit number displayed first is the main indoor unit number.
- In the non-group control mode (only one indoor unit), only 1-1 is displayed on the left.
The displayed 1-1 indicates the address of the piping system and the address of the indoor unit.
- If other indoor units are connected to the same remote controller (group control), when [▼] or [▲] button is pushed, the addresses of other indoor units will be displayed in order.

2 Push [ON/OFF] button to exit after checking.

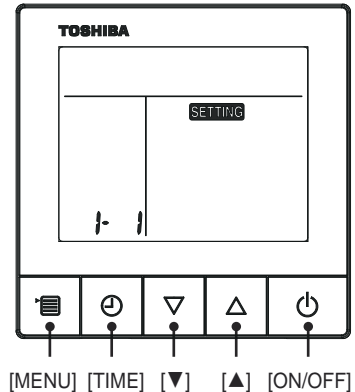

2. To know the position of indoor unit by address

- To confirm the unit No. in the group control
(Follow to the procedure during operation) (in this procedure, the indoor units in group control stop.)

<Procedure>

The indoor unit numbers in the group control are successively displayed, and fan, louver, and drain pump of the corresponding indoor unit are turned on.
(Follow to the procedure during operation)

1 Push [MENU] and [▼] buttons simultaneously for at least 10 seconds.

- In the air-conditioning group control mode, **SETTING** and the indoor unit No. are displayed. The indoor unit number displayed first is the main indoor unit number.
- In the non-group control mode (only one indoor unit), only 1-1 is displayed on the left.
The displayed 1-1 indicates the address of the piping system and the address of the indoor unit.

2 Push [▼] or [▲] button to adjust the indoor unit address. The indoor unit number in the group control will be changed cyclically. Select the indoor unit number to be identified, and push [TIME] button to confirm. The fan of the selected indoor unit starts its operation and the swing operation of the louvers starts after confirmation to determine the position of the indoor unit.

3 Push [ON/OFF] button to return to the normal mode after confirmation.

When [ON/OFF] button is pushed, **SETTING** flashes, then the display disappears and the air conditioner enters the normal stop mode.
(When **SETTING** flashes, it cannot receive operation instructions from the remote controller.)

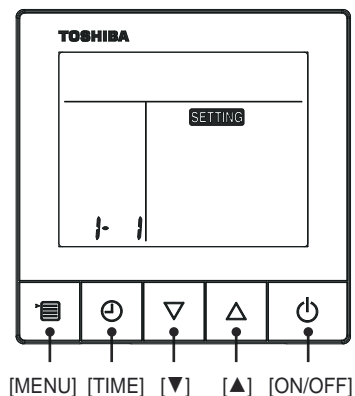

◆ Changing the indoor unit address using a remote controller

To change an indoor unit address using a wired remote controller.

- ▼ The method to change the address of an individual indoor unit (the indoor unit is paired with a wired remote controller one-to-one), or an indoor unit in a group.
(The method is available when the addresses have already been set automatically.)

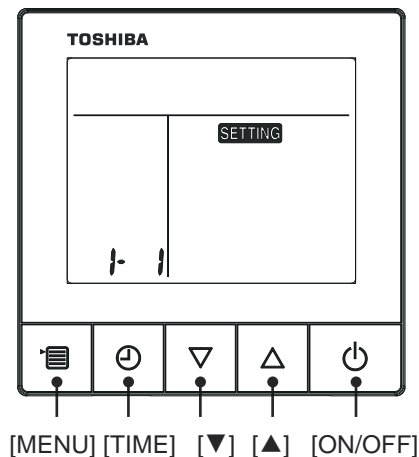

(Perform this operation when the air conditioner is stopped)

1 Push [MENU] and [▼] buttons simultaneously for at least 10 seconds.

- In the air-conditioning group control mode, **SETTING** and the indoor unit No. are displayed. The indoor unit number displayed first is the main indoor unit number.
- In the non-group control mode (only one indoor unit), only 1-1 is displayed on the left. The displayed 1-1 indicates the address of the piping system and the address of the indoor unit.

2 Push [▼] or [▲] button to adjust the indoor unit number. The indoor unit number in the group control will be changed cyclically. Select an indoor unit to change the settings and push [TIME] button to confirm.

The fan of the selected indoor unit starts its operation and the swing operation of the louvers starts after confirmation.

3 Using [▼] or [▲] button, set the CODE No. to [13].

4 Use [MENU] button to adjust the flash from CODE No. to SET DATA on the left. Select the specified SET DATA [**] as required.**

5 Push [MENU] button to adjust the flash to CODE No. on the right after pushing [TIME] button to confirm.

6 Push [ON/OFF] button to complete the setting when the setting is completed.

- To change the settings of another indoor unit, repeat from step **1** to reselect the indoor unit number.
- Repeat steps **1** to **6** to change the indoor unit addresses so as to make each of them unique.

■ Check code clearing function

1. Clearing method from remote controller

Clearing a check code of the outdoor unit

Clear the currently detected outdoor unit for each refrigerant line to which the indoor unit controlled by the remote controller is connected. (The indoor unit check code is not cleared.)
Use the service monitoring function of the remote controller.

<Method>

- 1 Push and hold [MENU] button for at least 10 seconds to call the service monitor mode.**
The service monitor indicator lights up and displays the main indoor unit number first.
- 2 Push [▼] or [▲] button, select the indoor unit number to be monitored, and push [TIME] button to enter the sensor monitor interface.**
[00] is displayed at the CODE No.
- 3 Using [▼] or [▲] button, set the CODE No. to [FF].**
A 5-second countdown figure is displayed on the left:
[0005]→[0004]→[0003]→[0002]→[0001]→[0000]
The check code is cleared when it reaches [0000].
* The countdown figure from [0005] is repeatedly displayed.
- 4 Push [ON/OFF] button to complete the setting.**

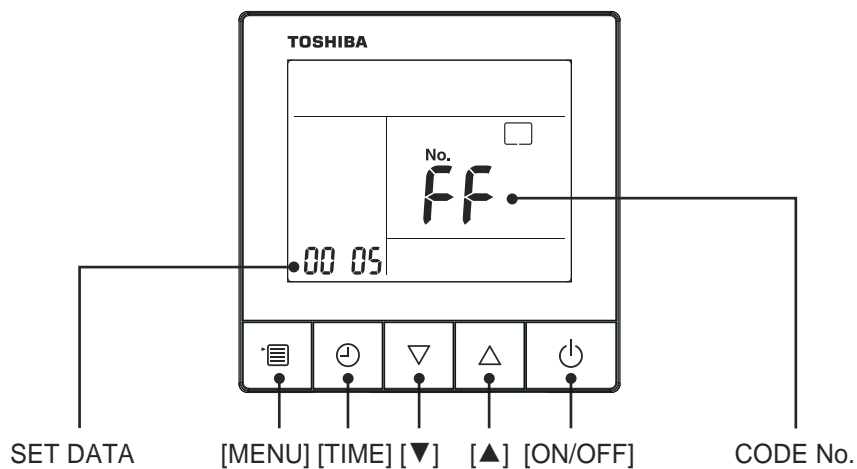

Clearing a check code of the indoor unit

Push the ON / OFF button on the remote controller.
(Only the check code of the indoor unit controlled by the remote controller will be cleared.)

■ Monitoring function of remote controller switch

When using the remote controller (Model Name: RBC-ASCU11*), the following monitoring function can be utilized.

Calling of display

<Contents>

The temperature of each sensor of the remote controller, indoor unit and outdoor unit and the operating status can be checked by calling the service monitor mode from the remote controller.

<Procedure>

- 1** Push and hold [MENU] button for at least 10 seconds to call the service monitor mode.
(It is possible to enable the switch monitor mode during the normal operation or shutting down)
The service monitor indicator lights up and displays the main indoor unit number first.



- 2** Push [▼] or [▲] button, select the indoor unit number to be monitored, and push [TIME] button to enter the sensor monitor interface.
The temperature of CODE No. [00] is displayed first. The number on the left represents the current temperature.



- 3** Push [▼] or [▲] button to select the sensor number (CODE No.) to monitor.
(See table below)

- The SET DATA at the left side shows the corresponding sensor temperature.
- The sensor temperature of the indoor unit, the refrigerant line temperature of the outdoor unit, and the current ambient temperature are all within the monitor range.
- The data value of each item is not the real time, but value delayed by a few seconds.



- 4** Push [ON/OFF] button to return to the normal display.

If it is required to call other indoor unit temperature to display, please repeat from step **1**.

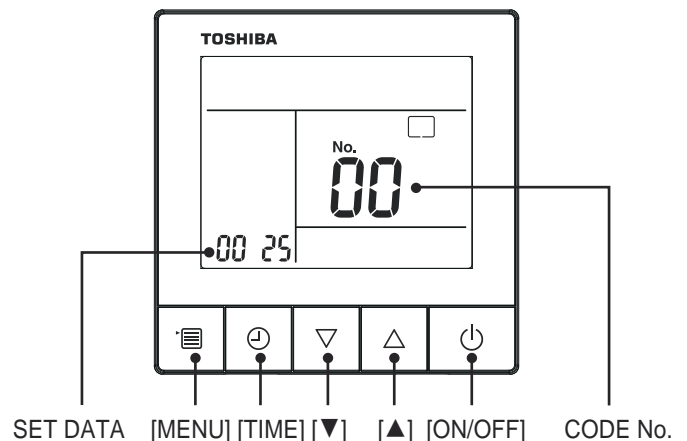

◆ Indoor service monitor list

	Code No.	Data name	Display format	Unit	Remote controller display example
Indoor unit data *	00	Room temperature (Use to control)	x1	°C	
	01	Room temperature (Remote controller)	x1	°C	
	02	Indoor suction air temperature (TA)	x1	°C	
	03	Indoor coil temperature (TCJ)	x1	°C	
	04	Indoor coil temperature (TC2)	x1	°C	
	05	Indoor coil temperature (TC1)	x1	°C	
	06	Indoor discharge air temperature (TF) *	x1	°C	
	07	Indoor fan motor number of revolutions**	x1	rpm	[0600] = 600rpm
	08	Indoor PMV opening	x1/10	pls	[0150]=1500pls
	F3	Filter sign time	x1	h	[2500] = 2500h
	F9	Suction temperature of air to air heat exchanger (TSA) *	x1	°C	[0024] = 24°C
FA	Outside air temperature (TOA) *	x1	°C		

* When the units are connected to a group, data of the header indoor unit only can be displayed.

** There is also a model which cannot be displayed.

- Refer to the service manual of an outdoor unit for "outdoor service monitor list".

■ LED display on P.C. board

1. D501 (Red)

- D501 goes on at the same time when the power supply is turned on.
(Goes on with operation of the main microprocessor)
- D501 flashes with 1-second interval (every 0.5 second) : When there is no EEPROM or write-in trouble
- D501 flashes with 10-seconds interval (every 5 second) : In DISP mode
- D501 flashes with 2-seconds interval (every 1 second) : During setting of function exchange
(EEPROM)

2. D403 (Red)

- D403 goes on when power is supplied to the remote controller. (ON in hardware)

3. D503 (Yellow): Indoor/Outdoor central control

- D503 goes on for 5 seconds at the first half during communication with the central controller.
- D503 flashes for 5 seconds with 0.2-second interval at the latter half during communication with outdoor unit. (Goes on for 0.1 second, goes off for 0.1 second)

4. D504 (Green): Remote controller communication

- D504 goes on for 5 seconds at the first half during communication with remote controller.
(Header unit of group)
- In the group indoor unit, D504 flashes for 5 seconds with 0.2-second interval at the latter half during communication between header and follower unit. (Goes on for 0.1 second, goes off for 0.1 second)

10. TROUBLESHOOTING

10-1. Overview

(1) Before engaging in troubleshooting

(a) Applicable models

All Super Modular Multi System (SMMS-*) models.

(Indoor units: MM*-UP***, Outdoor units: MMY-M*P***)

(b) Tools and measuring devices required

- Screwdrivers (Philips, flat head), spanners, long-nose pliers, nipper, pin to push reset switch, etc.
- Multimeter, thermometer, pressure gauge, etc.

(c) Things to check prior to troubleshooting (behaviors listed below are normal)

NO.	Behavior	Possible cause
1	A compressor would not start	<ul style="list-style-type: none"> • The air conditioner is being controlled by the 3-minute protective function. • It is in standby status though the room temperature has reached the setup temperature. • It is being operated in timer mode or fan mode. • It is being in initial communication.
2	An indoor fan would not start	<ul style="list-style-type: none"> • The air conditioner is being controlled by the cool air discharge preventive function in "heating"?
3	An outdoor fan would not start or would change speed for no reason	<ul style="list-style-type: none"> • The air conditioner is being operated in "cooling" under the low outside air temperature. • It is being operated in defrost operation.
4	An indoor fan would not stop	<ul style="list-style-type: none"> • The air conditioner is being controlled by function of residual heat elimination being performed as part of the air conditioner shutdown process after heating operation.
5	The air conditioner would not respond to a start/stop command from a remote controller	<ul style="list-style-type: none"> • The air conditioner is being operated under external or remote controller.

CAUTION

The cooling performance may be declining considerably when total operating capacity of cooling indoor units is less than 4 HP while ambient temperature is below.

(2) Troubleshooting procedure

When a problem occurs, proceed with troubleshooting in accordance with the procedure shown below.

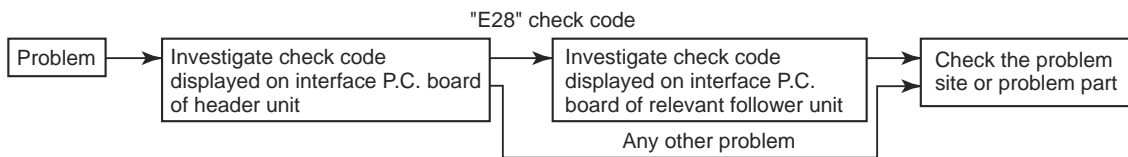

NOTE

Rather than a product trouble (see the List of Check Codes below), the problem could have been caused by a microprocessor malfunction attributable to a poor quality of the power source or an external noise. Check for possible noise sources, and shield the remote controller wiring and signal wires as necessary.

10-2. Troubleshooting method

The remote controllers (main remote controller and central control device) and the interface P.C. board of an outdoor unit are provided with an a 7-segment display (outdoor interface P.C. board) to display operational status. Using this self-diagnosis feature, the trouble site / trouble part may be identified in the event of a trouble by following the method described below.

The list below summarizes check codes detected by various devices. Analyze the check code according to where it is displayed and work out the nature of the trouble in consultation with the list.

- When investigating a trouble on the basis of a display provided on the indoor remote controller or central control device - See the “central control device or main remote controller display” section of the list.
- When investigating a trouble on the basis of a display provided on an outdoor unit - See the “Outdoor 7-segment display” section of the list.
- When investigating a trouble on the basis of a wireless remote controller-controlled indoor unit - See the “Indicator light block” section of the list.

List of check codes (indoor unit)

(Check code detected by indoor unit)

IPDU: Compressor / Fan inverter P.C. board

○: Lighting, ⊙: Flashing, ●: Goes off

ALT.: Flashing is alternately when there are two flashing LED

SIM: Simultaneous flashing when there are two flashing LED

Check code		Display of receiving unit				Typical trouble on site	Description of check code	
Remote controller display	Outdoor 7-segment display	Indicator light block			Flash			
	Sub-code	Operation ⏻	Timer ⌚	Ready ⊙		Flash		
E03	—	—	⊙	●	●	Indoor-remote controller periodic communication check code	Communication from remote controller or network adaptor has been lost (so has central control communication).	
E04	—	—	●	●	⊙	Indoor-outdoor periodic communication check code	Signals are not being received from outdoor unit.	
E08	E08	Duplicated indoor address	⊙	●	●	Duplicated indoor address	Indoor unit detects address identical to its own.	
E10	—	—	⊙	●	●	Communication trouble between indoor unit MCU	Communication trouble between main MCU and the motor microcomputer MCU	
E11	—	—	⊙	●	●	Communication check code between Application control kit and indoor unit	Communication check code between Application control kit and indoor unit P.C. board	
E18	—	—	⊙	●	●	Check cod in periodic communication between indoor header and follower unit	Periodic communication between indoor header and follower units cannot be maintained.	
F01	—	—	⊙	⊙	●	ALT	Indoor heat exchanger temperature sensor (TCJ) check code	Heat exchanger temperature sensor (TCJ) has been open / short-circuit.
F02	—	—	⊙	⊙	●	ALT	Indoor heat exchanger temperature sensor (TC2) check code	Heat exchanger temperature sensor (TC2) has been open / short-circuit.
F03	—	—	⊙	⊙	●	ALT	Indoor heat exchanger temperature sensor (TC1) check code	Heat exchanger temperature sensor (TC1) has been open / short-circuit.
F10	—	—	⊙	⊙	●	ALT	Ambient temperature sensor (TA) check code	Ambient temperature sensor (TA) has been open / short-circuit.
F11	—	—	⊙	⊙	●	ALT	Discharge temperature sensor (TF) check code	Discharge temperature sensor (TF) has been open / short-circuit.
F29	—	—	⊙	⊙	●	SIM	P.C. board or other indoor check code	Indoor EEPROM is abnormal (some other trouble may be detected).
F30	—	—	⊙	⊙	○	ALT	Occupancy sensor trouble	Occupancy sensor trouble has been detected.
L03	—	—	⊙	●	⊙	SIM	Duplicated indoor group header unit	There is more than one header unit in group.
L07	—	—	⊙	●	⊙	SIM	Connection of group control cable to a single indoor unit	There is at least one a single indoor unit to which group control cable is connected.
L08	L08	—	⊙	●	⊙	SIM	Indoor group address not set	Address setting has not been performed for one or more indoor units (also detected at outdoor unit end).
L09	—	—	⊙	●	⊙	SIM	Indoor capacity not set	Capacity setting has not been performed for indoor unit.
L20	—	—	⊙	○	⊙	SIM	Duplicated central control address	There is duplication in central control address setting.
L30	L30	Detected indoor unit No.	⊙	○	⊙	SIM	Indoor external check code input (interlock)	Unit shutdown has been caused by external check code input (CN80).
P01	—	—	●	⊙	⊙	ALT	Indoor AC fan check code	Indoor AC fan check code is detected (activation of fan motor thermal relay).
P10	P10	Detected indoor unit No.	●	⊙	⊙	ALT	Indoor overflow check code	Float switch has been activated.
P12	—	—	●	⊙	⊙	ALT	Indoor DC fan check code	• Indoor DC fan check code (e.g. overcurrent or lock-up) is detected.
P31	—	—	⊙	●	⊙	ALT	Other indoor unit check code	Follower unit cannot be operated due to header unit alarm (E03 / L03 / L07 / L08).

(Check code detected by remote controller)

Check code			Display of receiving unit				Typical trouble site	Description of trouble
Remote control	Outdoor 7-segment display		Indicator light block					
		Sub-code	Operation ⏻	Timer ⌚	Ready ⊕	Flash		
E01	-	-	⊙	●	●		No master remote control, failure remote control communication (reception)	Signals cannot be received from indoor unit; master remote control has not been set (including two remote control).
E02	-	-	⊙	●	●		Failure remote control communication (transmission)	Signals cannot be transmitted to indoor unit.
E09	-	-	⊙	●	●		Duplicated master remote control	Both remote controls have been set as master remote control in two remote control (alarm and shutdown for header unit and continued operation for follower unit)

(Check code detected by central control device)

Check code			Display of receiving unit				Typical trouble site	Description of trouble
Central control	Outdoor 7-segment display		Indicator light block					
		Sub-code	Operation ⏻	Timer ⌚	Ready ⊕	Flash		
C05	-	-	No indication (when main remote control also in use)				Failure central control communication (transmission)	Central control device is unable to transmit signal due to duplication of central control device
C06	-	-					Failure central control communication (reception)	Central control device is unable to receive signal.
C12	-	-	-				Bracket alarm for general-purpose device control interface	Device connected to general-purpose device control interface is trouble.
P30 (L20)	-	-	(L20 is displayed.)				Communication Link	<ul style="list-style-type: none"> • Duplication addresses of indoor units in central control device • With the combination of air conditioning system, the indoor unit may detect the check code of L20

Note: The same trouble, e.g. a communication trouble, may result in the display of different check codes depending on the device that detects it. Moreover, check codes detected by the main remote controller / central control device do not necessarily have a direct impact on air conditioner operation.

Flow selector unit (FS unit) Relation

(Check code detected by indoor unit)

Check code			Display of receiving unit				Typical trouble site	Description of trouble
Main remote control	Outdoor 7-segment display		Indicator light block					
		Sub-code	Operation ⏻	Timer ⌚	Ready ⊕	Flash		
E17	-	-	⊙	●	●		Communication trouble between indoor unit (s) and FS unit (s)	There is no communication from FS unit(s)
J03	-	-	●	⊙	⊙		Duplicated FS units	More than one FS units have been set up in one refrigerant line.
J10	-	-	●	⊙	⊙		FS unit overflow trouble	FS unit has been shutdown in one refrigerant line due to detection of overflow
J11	-	-	●	⊙	⊙		FS unit temperature sensor (TCS) trouble	FS unit temperature sensor (TCS) has been open/short-circuited.
L12	L12	-	⊙	○	⊙		FS unit(s) system trouble	FS unit(s) outside the application setting

List of Check Codes (Outdoor Unit)

(Check code detected by outdoor interface - typical examples)

If "HELLO" is displayed on the outdoor 7-segment for 1 minute or more, turn off the power supply once and then turn on the power supply again after passage of 30 seconds or more. When the same symptom appears, it is considered there is a possibility of I/F board trouble.

○ : Lighting, ◎ : Flashing, ● : Goes off
 ALT.: Flashing is alternately when there are two flashing LED
 SIM: Simultaneous flashing when there are two flashing LED



Check code		Display of receiving unit		Typical problem site	Description of problem																																																																																										
Outdoor 7-segment display		Central control or main remote controller display	Indicator light block																																																																																												
Sub-code			Operation ⏻	Timer ⌚	Ready ⚙️	Flash																																																																																									
E06	Number of indoor units from which signal is received normally	E06	●	●	◎	Signal lack of indoor unit	<ul style="list-style-type: none"> Indoor unit initially communicating normally fails to return signal (reduction in number of indoor units connected). In TU2C-LINK communication system, if the termination resistance is not set in any of the indoor units. 																																																																																								
E07	—	(E04)	●	●	◎	Indoor-outdoor communication circuit trouble	Signal cannot be transmitted to indoor units (→ indoor units left without communication from outdoor unit).																																																																																								
E08	Duplicated indoor address	(E08)	◎	●	●	Duplicated indoor address	More than one indoor unit are assigned same address (also detected at indoor unit end).																																																																																								
E12	01: Indoor-outdoor communication 02: Outdoor-outdoor communication	E12	◎	●	●	Automatic address starting trouble	<ul style="list-style-type: none"> Indoor automatic address setting is started while automatic address setting for equipment in other refrigerant line is in progress. Outdoor automatic address setting is started while automatic address setting for indoor units is in progress. 																																																																																								
E15	—	E15	●	●	◎	Indoor unit not found during automatic address setting	Indoor unit fails to communicate while automatic address setting for indoor units is in progress.																																																																																								
E16	00: Capacity over 01: Number of units connected	E16	●	●	◎	Too many indoor units connected/capacity over	Combined capacity of indoor units is too large. The maximum combined of indoor units shown in the specification table.																																																																																								
E19	00: No header unit 02: Two or more header units	E19	●	●	◎	Trouble in number of outdoor header units	There is no or more than one outdoor header unit in one refrigerant line.																																																																																								
E20	01: Connection of outdoor unit from other refrigerant line 02: Connection of indoor unit from other refrigerant line	E20	●	●	◎	Connection to other refrigerant line found during automatic address setting	Indoor unit from other refrigerant line is detected while indoor automatic address setting is in progress.																																																																																								
E23	—	E23	●	●	◎	Outdoor-outdoor communication transmission trouble	Signal cannot be transmitted to other outdoor units.																																																																																								
E25	—	E25	●	●	◎	Duplicated follower outdoor address	There is duplication in outdoor addresses set manually.																																																																																								
E26	Address of outdoor unit from which signal is not received normally	E26	●	●	◎	Signal lack of outdoor unit	Follower outdoor unit initially communicating normally fails to do so (reduction in number of follower outdoor units connected).																																																																																								
E28	Detected outdoor unit No.	E28	●	●	◎	Outdoor follower unit trouble	Outdoor header unit detects trouble relating to follower outdoor unit (detail displayed on follower outdoor unit).																																																																																								
E31	<table border="1" style="font-size: small;"> <thead> <tr> <th colspan="4">P.C.board</th> <th colspan="4">P.C.board</th> </tr> <tr> <th colspan="2">Compressor</th> <th colspan="2">Fan Motor</th> <th colspan="2">Compressor</th> <th colspan="2">Fan Motor</th> </tr> <tr> <th>1</th><th>2</th><th>1</th><th>2</th><th>1</th><th>2</th><th>1</th><th>2</th> </tr> </thead> <tbody> <tr><td>01</td><td>○</td><td></td><td></td><td>11</td><td>○</td><td></td><td>○</td></tr> <tr><td>02</td><td>○</td><td></td><td></td><td>12</td><td></td><td>○</td><td>○</td></tr> <tr><td>03</td><td>○</td><td>○</td><td></td><td>13</td><td>○</td><td>○</td><td>○</td></tr> <tr><td>08</td><td></td><td></td><td>○</td><td>18</td><td></td><td></td><td>○</td></tr> <tr><td>09</td><td>○</td><td></td><td>○</td><td>19</td><td>○</td><td></td><td>○</td></tr> <tr><td>0A</td><td></td><td>○</td><td>○</td><td>1A</td><td></td><td>○</td><td>○</td></tr> <tr><td>0B</td><td>○</td><td>○</td><td>○</td><td>1B</td><td>○</td><td>○</td><td>○</td></tr> <tr><td>10</td><td></td><td></td><td>○</td><td></td><td></td><td></td><td>○</td></tr> </tbody> </table> <p>80 : Communication trouble between MCU and Sub MCU Circle (○) : Trouble P.C. board</p>	P.C.board				P.C.board				Compressor		Fan Motor		Compressor		Fan Motor		1	2	1	2	1	2	1	2	01	○			11	○		○	02	○			12		○	○	03	○	○		13	○	○	○	08			○	18			○	09	○		○	19	○		○	0A		○	○	1A		○	○	0B	○	○	○	1B	○	○	○	10			○				○	E31	●	●	◎	P.C. board communication trouble Sub MCU communication trouble	There is no communication between P.C. boards in inverter box.
P.C.board				P.C.board																																																																																											
Compressor		Fan Motor		Compressor		Fan Motor																																																																																									
1	2	1	2	1	2	1	2																																																																																								
01	○			11	○		○																																																																																								
02	○			12		○	○																																																																																								
03	○	○		13	○	○	○																																																																																								
08			○	18			○																																																																																								
09	○		○	19	○		○																																																																																								
0A		○	○	1A		○	○																																																																																								
0B	○	○	○	1B	○	○	○																																																																																								
10			○				○																																																																																								
F04	—	F04	◎	◎	○	ALT	Outdoor discharge temperature sensor (TD1) trouble	Outdoor discharge temperature sensor (TD1) has been open/short-circuited.																																																																																							
F05	—	F05	◎	◎	○	ALT	Outdoor discharge temperature sensor (TD2) trouble	Outdoor discharge temperature sensor (TD2) has been open/short-circuited.																																																																																							
F06	01: TE1 sensor 02: TE2 sensor 03: TE3 sensor	F06	◎	◎	○	ALT	Outdoor heat exchanger liquid side temperature sensor (TE1, TE2, TE3) trouble	Outdoor heat exchanger liquid side temperature sensors (TE1, TE2, TE3) have been open/short-circuited.																																																																																							
F07	01: TL1 sensor 02: TL2 sensor 03: TL3 sensor	F07	◎	◎	○	ALT	Outdoor liquid temperature sensor (TL1, TL2, TL3) trouble	Outdoor liquid temperature sensor (TL1, TL2, TL3) has been open/short-circuited.																																																																																							
F08	—	F08	◎	◎	○	ALT	Outdoor outside air temperature sensor (TO) trouble	Outdoor air temperature sensor (TO) has been open/short-circuited.																																																																																							
F09	01: TG1 sensor 02: TG2 sensor 03: TG3 sensor	F09	◎	◎	○	ALT	Outdoor heat exchanger gas side temperature sensor (TG1, TG2, TG3) trouble	Outdoor heat exchanger gas side temperature sensors (TG1, TG2, TG3) have been open/short-circuited.																																																																																							

Check code		Display of receiving unit				Typical problem site	Description of problem	
Outdoor 7-segment display		Central control or main remote controller display	Indicator light block					
Sub-code			Operation 	Timer 	Ready 	Flash		
F12	01: TS1 sensor 03: TS3 sensor	F12	☉	☉	○	ALT	Outdoor suction temperature sensor (TS1,TS3) trouble	Outdoor suction temperature sensor (TS1,TS3) has been open/short-circuited.
F15	–	F15	☉	☉	○	ALT	Outdoor temperature sensor (TE1,TL1) wiring trouble	Wiring trouble in outdoor temperature sensors (TE1,TL1) has been detected.
F16	–	F16	☉	☉	○	ALT	Outdoor pressure sensor (Pd, Ps) wiring trouble	Wiring trouble in outdoor pressure sensors (Pd, Ps) has been detected.
F23	–	F23	☉	☉	○	ALT	Low pressure sensor (Ps) trouble	Output voltage of low pressure sensor (Ps) is zero.
F24	–	F24	☉	☉	○	ALT	High pressure sensor (Pd) trouble	Output voltage of high pressure sensor (Pd) is zero or provides abnormal readings when compressors have been turned off.
F31	–	F31	☉	☉	○	SIM	Outdoor EEPROM trouble	Outdoor EEPROM is failure (alarm and shutdown for header unit and continued operation for follower unit)
H05	–	H05	●	☉	●		Outdoor discharge temperature sensor (TD1) wiring trouble	Wiring/installation trouble or detachment of outdoor discharge temperature sensor (TD1) has been detected.
H06	–	H06	●	☉	●		Activation of low-pressure protection	Low pressure (Ps) sensor detects abnormally low operating pressure.
H07	–	H07	●	☉	●		Low oil level protection	Temperature sensor for oil level detection (TK1,TK2) detects abnormally low oil level.
H08	01: TK1 sensor trouble 02: TK2 sensor trouble	H08	●	☉	●		Trouble in temperature sensor for oil level detection (TK1,TK2)	Temperature sensor for oil level detection (TK1,TK2) has been open/short-circuited.
H15	–	H15	●	☉	●		Outdoor discharge temperature sensor (TD2) wiring trouble	Wiring/installation trouble or detachment of outdoor discharge temperature sensor (TD2) has been detected.
H16	01: TK1 oil circuit trouble 02: TK2 oil circuit trouble	H16	●	☉	●		Oil level detection circuit trouble	No temperature change is detected by temperature sensor for oil level detection (TK1,TK2) despite compressor having been started.
L04	–	L04	☉	○	☉	SIM	Duplicated outdoor refrigerant line address	Identical refrigerant line address has been assigned to outdoor units belonging to different refrigerant piping systems.
L06	Number of priority indoor units (check code L05 or L06 depending on individual unit)	L05	☉	●	☉	SIM	Duplicated priority indoor unit (as displayed on priority indoor unit)	More than one indoor unit have been set up as priority indoor unit.
		L06	☉	●	☉	SIM	Duplicated priority indoor unit (as displayed on indoor unit other than priority indoor unit)	More than one indoor unit have been set up as priority indoor unit.
L08	–	(L08)	☉	●	☉	SIM	Indoor group address not set	Address setting have not been performed for one or more indoor units (also detected at indoor end).
L10	–	L10	☉	○	☉	SIM	Outdoor capacity not set	Outdoor unit capacity has not been set (after P.C. board replacement).
L17	–	L17	☉	○	☉	SIM	Outdoor model incompatibility trouble	Old model outdoor unit has been connected.
L23	–	L23	☉	○	☉	SIM	SW setting mistake	
L28	–	L28	☉	○	☉	SIM	Too many outdoor units connected	More than five outdoor units have been connected.

Check code			Display of receiving unit				Typical problem site	Description of problem																																																																																									
Outdoor 7-segment display			Indicator light block																																																																																														
Sub-code	Central control or main remote controller display		Operation	Timer	Ready	Flash																																																																																											
	Compressor	Fan Motor	(1)	(2)	(3)																																																																																												
L29	<table border="1"> <thead> <tr> <th colspan="4">P.C.board</th> <th colspan="4">P.C.board</th> </tr> <tr> <th colspan="2">Compressor</th> <th colspan="2">Fan Motor</th> <th colspan="2">Compressor</th> <th colspan="2">Fan Motor</th> </tr> <tr> <th>1</th><th>2</th><th>1</th><th>2</th><th>1</th><th>2</th><th>1</th><th>2</th> </tr> </thead> <tbody> <tr><td>01</td><td>○</td><td></td><td></td><td>11</td><td>○</td><td></td><td>○</td></tr> <tr><td>02</td><td></td><td>○</td><td></td><td>12</td><td></td><td>○</td><td></td></tr> <tr><td>03</td><td>○</td><td>○</td><td></td><td>13</td><td>○</td><td>○</td><td>○</td></tr> <tr><td>08</td><td></td><td></td><td>○</td><td>18</td><td></td><td></td><td>○</td></tr> <tr><td>09</td><td>○</td><td></td><td>○</td><td>19</td><td>○</td><td></td><td>○</td></tr> <tr><td>0A</td><td></td><td>○</td><td>○</td><td>1A</td><td></td><td>○</td><td>○</td></tr> <tr><td>0B</td><td>○</td><td>○</td><td>○</td><td>1B</td><td>○</td><td>○</td><td>○</td></tr> <tr><td>10</td><td></td><td></td><td>○</td><td></td><td></td><td></td><td></td></tr> </tbody> </table>		P.C.board				P.C.board				Compressor		Fan Motor		Compressor		Fan Motor		1	2	1	2	1	2	1	2	01	○			11	○		○	02		○		12		○		03	○	○		13	○	○	○	08			○	18			○	09	○		○	19	○		○	0A		○	○	1A		○	○	0B	○	○	○	1B	○	○	○	10			○					L29	◎	○	◎	SIM	Trouble in number of P.C. boards	There are insufficient number of P.C. board in inverter box.
	P.C.board				P.C.board																																																																																												
	Compressor		Fan Motor		Compressor		Fan Motor																																																																																										
	1	2	1	2	1	2	1	2																																																																																									
	01	○			11	○		○																																																																																									
	02		○		12		○																																																																																										
	03	○	○		13	○	○	○																																																																																									
	08			○	18			○																																																																																									
	09	○		○	19	○		○																																																																																									
	0A		○	○	1A		○	○																																																																																									
	0B	○	○	○	1B	○	○	○																																																																																									
10			○																																																																																														
00		L29	◎	○	◎	SIM	The number of P.C. board trouble	When there is much number of an inverter P.C. board to model setting of an interface P.C. board.																																																																																									
L30	Detected indoor unit No.	(L30)	◎	○	◎	SIM	Indoor external trouble input (interlock)	Indoor unit has been shut down for external trouble input in one refrigerant line (detected by indoor unit).																																																																																									
P03	–	P03	◎	●	◎	ALT	Outdoor discharge (TD1) temperature trouble	Outdoor discharge temperature sensor (TD1) has detected abnormally high temperature.																																																																																									
P05	00: Power detection trouble 01: Open phase 02: Power supply miswiring	P05	◎	●	◎	ALT	Power detection trouble /Open phase detection /Power supply miswiring detection	Open phase is detected when power is turned on. Inverter DC voltage is too high (overvoltage) or too low (undervoltage).																																																																																									
P07	1 : Compressor 1 heat sink trouble 2 : Compressor 2 heat sink trouble	P07	◎	●	◎	ALT	Heat sink overheating trouble	Temperature sensor built into IPM (TH) detects overheating.																																																																																									
	04: Heat sink dew condensation						Heat sink dew condensation trouble	Outdoor liquid temperature sensor (TL2) has detected abnormally low temperature.																																																																																									
P10	Indoor unit No. detected	(P10)	●	◎	◎	ALT	Indoor unit overflow	Indoor unit has been shutdown in one refrigerant line due to detection of overflow (detected by indoor unit).																																																																																									
P11	–	P11	●	◎	◎	ALT	Outdoor heat exchanger freeze trouble	Remaining frost on outdoor heat exchanger has been detected repeatedly.																																																																																									
P13	–	P13	●	◎	◎	ALT	Outdoor liquid backflow detection trouble	State of refrigerant cycle circuit indicates liquid backflow operation.																																																																																									
P15	01: TS condition 02: TD condition	P15	◎	●	◎	ALT	Gas leak detection	Outdoor suction temperature sensor (TS1) detects sustained and repeated high temperatures that exceed standard value.																																																																																									
P17	–	P17	◎	●	◎	ALT	Outdoor discharge (TD2) temperature trouble	Outdoor discharge temperature sensor (TD2) detects abnormally high temperature.																																																																																									
P19	Outdoor unit No. detected	P19	◎	●	◎	ALT	4-way valve reversing trouble	Abnormality in refrigerating cycle is detected during heating operation.																																																																																									
P20	–	P20	◎	●	◎	ALT	Activation of high-pressure protection	High pressure (Pd) sensor detects high pressure that exceeds standard value.																																																																																									

MG-CTT: Magnet contactor

(Check code detected by Inverter of Compressor featuring in outdoor unit - typical examples)

Check code		Display of receiving unit				Typical problem site	Description of proplem
Outdoor 7-segment display		Central control or main remote controller display	Indicator light block				
Sub-code			Operation 	Timer 	Ready 	Flash	
F13	1*: Compressor 1 2*: Compressor 2	F13	⊙	⊙	○	ALT	Trouble in temperature sensor built into indoor IPM (TH) has been open/short-circuited.
H01	1*: Compressor 1 2*: Compressor 2	H01	●	⊙	●		Compressor breakdown Inverter current (Idc) detection circuit detects overcurrent.
H02	1*: Compressor 1 2*: Compressor 2	H02	●	⊙	●		Compressor trouble (lockup) Compressor lockup is detected
H03	1*: Compressor 1 2*: Compressor 2	H03	●	⊙	●		Current detection circuit trouble Abnormal current is detected while inverter compressor is turned off.
P04	01: Compressor 1 02: Compressor 2	P04	⊙	●	⊙	ALT	Activation of high-pressure SW High-pressure SW is activated.
P05	01: Compressor 1 side 02: Compressor 2 side	P05	⊙	●	⊙	ALT	Compressor Vdc trouble Inverter DC voltage is too high (overvoltage) or too low (undervoltage).
P07	01: Compressor 1 side 02: Compressor 2 side	P07	⊙	●	⊙	ALT	Heat sink overheat trouble Temperature sensor built into IPM (TH) detects overheating.
P11	–	P11	●	⊙	⊙	ALT	Outdoor heat exchanger freeze trouble Remaining frost on outdoor heat exchanger has been detected repeatedly.
P22	1*: Fan P.C. board 1 2*: Fan P.C. board 2	P22	⊙	●	⊙	ALT	Outdoor fan P.C. board trouble Outdoor fan P.C. board detects trouble.
P26	1*: Compressor 1 2*: Compressor 2	P26	⊙	●	⊙	ALT	Activation of IPM, compressor short-circuit protection Short-circuit protection for compressor motor driver circuit components is activated (momentary overcurrent).
P29	1*: Compressor 1 2*: Compressor 2	P29	⊙	●	⊙	ALT	Compressor position detection circuit trouble Compressor motor position detection trouble is detected.

Note: The above check codes are examples only, and different check codes may be displayed depending on the outdoor unit configuration

10-3. Troubleshooting based on information displayed on remote controller

<RBC-AMT***>

(1) Checking and testing

When a trouble occurs to an air conditioner, a check code and indoor unit No. are displayed on the display window of the remote controller. Check codes are only displayed while the air conditioner is in operation. If the display has already disappeared, access check code history by following the procedure described below.

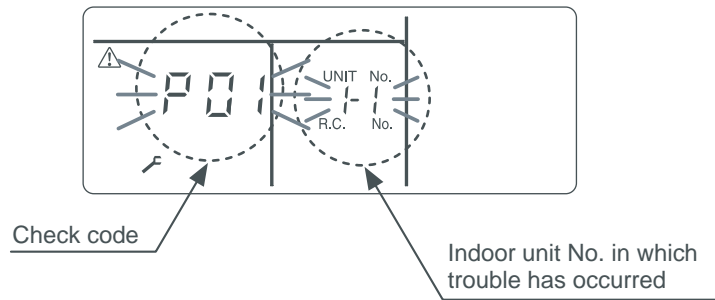

(2) Trouble history

The trouble history access procedure is described below (up to four check codes stored in memory). Check code history can be accessed regardless of whether the air conditioner is in operation or shut down.

<Procedure> To be performed when system at rest

1 Invoke the SERVICE CHECK mode by pressing the **TEST** + **SET** buttons simultaneously and holding for at least 4 seconds.

The letters "SERVICE CHECK" light up, and the check code "01" is displayed, indicating the trouble history. This is accompanied by the indoor unit No. to which the trouble history is related and a check code.

2 To check other trouble history items, press the **TEMP.** button to select another check code.

Check code "01" (latest) → Check code "04" (oldest)
Note: Trouble history contains four items.

3 When the **TEST** button is pushed, normal display is restored.

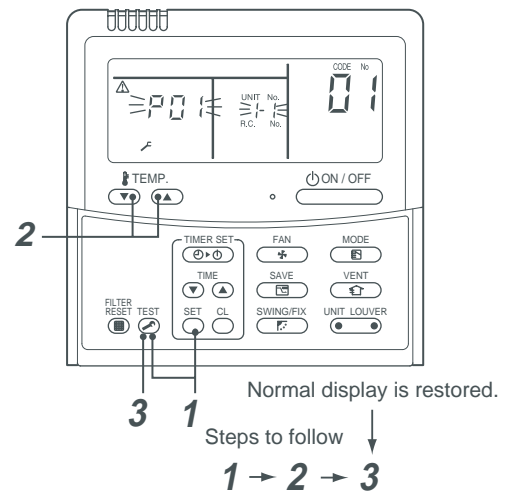

CAUTION

Do not push the **SET** button as it would erase the whole trouble history of the indoor unit.

<RBC-ASCU11-*>

(1) Confirmation and check

If a problem occurs with the air conditioner, the OFF timer indicator alternately shows the check code and the indoor Unit No. in which the problem occurred.

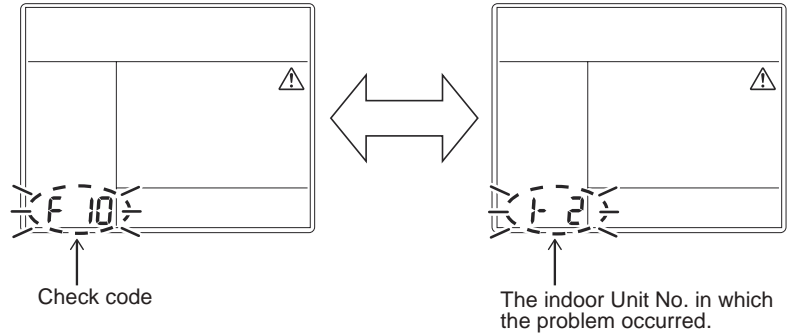

(2) Troubleshooting history and confirmation

You can check the troubleshooting history with the following procedure if a problem occurs with the air conditioner.

(The troubleshooting history records up to 4 incidents.)

You can check it during operation or when operation is stopped.

- If you check the troubleshooting history during OFF timer operation, the OFF timer will be canceled.

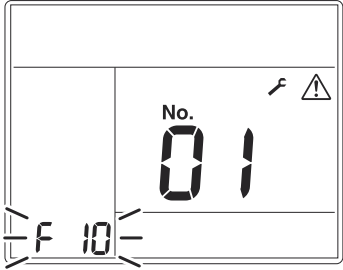
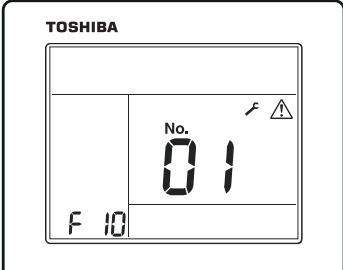
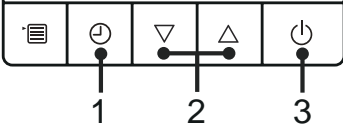
Procedure	Description of operation
<p>1</p>	<p>Push the OFF timer button for over 10 seconds and the indicators appear as an image indicating the troubleshooting history mode has been entered. If [ Service check] is displayed, the mode enters in the troubleshooting history mode.</p> <ul style="list-style-type: none"> • [01: Order of troubleshooting history] appears in the temperature indicator. • The OFF timer indicator alternately shows the [check code] and the [indoor Unit No.] in which the problem occurred. 
<p>2</p>	<p>Each time the setting button is pushed, the recorded troubleshooting history is displayed in sequence. The troubleshooting history appears in order from [01] (newest) to [04] (oldest).</p> <p>CAUTION</p> <p>In the troubleshooting history mode, DO NOT push the Menu button for over 10 seconds, doing so deletes the entire troubleshooting history of the indoor unit.</p> 
<p>3</p>	<p>After you have finished checking, push the ON/OFF button to return to the regular mode.</p> <ul style="list-style-type: none"> • If the air conditioner is operating, it remains operated even after the ON/OFF button has been pushed. To stop its operation, push the ON/OFF button again. 

How to read displayed information

<7-segment display symbols>



<Corresponding alphanumerical letters>

0 1 2 3 4 5 6 7 8 9 A b C d E F H J L P

Using indoor unit indicators (receiving unit light block) (wireless type)

To identify the check code, check the 7-segment display on the header unit. To check for check codes not displayed on the 7-segment display, consult the "List of Check Codes (Indoor Unit)" in "10-2. Troubleshooting method".

● : Goes off ○ : Lighting ☉ : Blinking (0.5 seconds)

Light block	Check code	Cause of trouble		
Operation ● Timer ● Ready ● All lights out	–	Power turned off or trouble in wiring between receiving and indoor units		
Operation ☉ Timer ● Ready ● Blinking	E01	Trouble reception	Receiving unit	Trouble or poor contact in wiring between receiving unit and indoor units
	E02	Trouble transmission		
	E03	Loss of communication		
	E08	Duplicated indoor unit No. (address)		Setting trouble
	E09	Duplicated master remote controller		
	E10	Communication trouble between indoor unit MCU		
	E11	Communication trouble between Application control kit and indoor unit P.C. board		
	E12	Automatic address starting trouble		
	E18	Trouble or poor contact in wiring between indoor units, indoor power turned off		
Operation ● Timer ● Ready ☉ Blinking	E04	Trouble or poor contact in wiring between indoor and outdoor units (loss of indoor-outdoor communication)		
	E06	<ul style="list-style-type: none"> • Trouble reception in indoor-outdoor communication (dropping out of indoor unit) • In TU2C-LINK communication system, if the termination resistance is not set in any of the indoor units 		
	E07	Trouble transmission in indoor-outdoor communication		
	E15	Indoor unit not found during automatic address setting		
	E16	Too many indoor units connected / overloading		
	E19	Trouble in number of outdoor header units		
	E20	Detection of refrigerant piping communication trouble during automatic address setting		
	E23	Trouble transmission in outdoor-outdoor communication		
	E25	Duplicated follower outdoor address		
	E26	Trouble reception in outdoor-outdoor communication, dropping out of outdoor unit		
	E28	Outdoor follower unit trouble		
	E31	P.C. board communication trouble		
	Operation ● Timer ☉ Ready ☉ Alternate blinking	P01	Indoor AC fan trouble	
P10		Indoor overflow trouble		
P11		Outdoor heat exchanger freezing trouble		
P12		Indoor DC fan trouble		
P13		Outdoor liquid backflow detection trouble		
Operation ☉ Timer ● Ready ☉ Alternate blinking	P03	Outdoor discharge (TD1) temperature trouble		
	P04	Activation of outdoor high-pressure SW		
	P05	Open phase / power failure Inverter DC voltage (Vdc) trouble MG-CTT trouble		
	P07	Outdoor heat sink overheating trouble - Poor cooling of electrical component (IGBT) of outdoor unit		
	P15	Gas leak detection - insufficient refrigerant charging		
	P17	Outdoor discharge (TD2) temperature trouble		
	P18	Outdoor discharge (TD3) temperature trouble		
	P19	Outdoor 4-way valve reversing trouble		
	P20	Activation of high-pressure protection		
	P22	Outdoor fan P.C. board trouble		
	P26	Outdoor IPM, Compressor short-circuit trouble		
	P29	Compressor position detection circuit trouble		
	P31	Shutdown of other indoor unit in group due to trouble (group follower unit trouble)		

MG-CTT: Magnet contactor

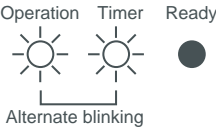
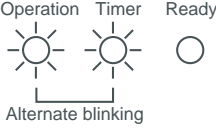
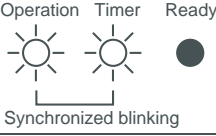
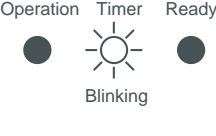
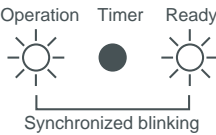
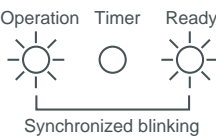
Light block	Check code	Cause of trouble		
Operation Timer Ready 	F01	Heat exchanger temperature sensor (TCJ) trouble	Indoor unit temperature sensor trouble	
	F02	Heat exchanger temperature sensor (TC2) trouble		
	F03	Heat exchanger temperature sensor (TC1) trouble		
	F10	Ambient temperature sensor (TA) trouble		
	F11	Discharge temperature sensor (TF) trouble		
Operation Timer Ready 	F04	Discharge temperature sensor (TD1) trouble	Outdoor unit temperature sensor trouble	
	F05	Discharge temperature sensor (TD2) trouble		
	F06	Heat exchanger temperature sensor (TE1, TE2) trouble		
	F07	Liquid temperature sensor (TL) trouble		
	F08	Outside air temperature sensor (TO) trouble		
	F09	TG1, TG2 or TG3 sensor trouble		
	F12	Suction temperature sensor (TS1) trouble		
	F13	Heat sink sensor (TH) trouble		
	F15	Wiring trouble in heat exchanger sensor (TE1) and liquid temperature sensor (TL) Outdoor unit temperature sensor wiring / installation trouble	Outdoor unit pressure sensor trouble	
	F16	Wiring trouble in outdoor high pressure sensor (Pd) and low pressure sensor (Ps) Outdoor pressure sensor wiring trouble		
	F22	Outdoor discharge temperature sensor (TD3) trouble		
	F23	Low pressure sensor (Ps) trouble		
	F24	High pressure sensor (Pd) trouble		
Operation Timer Ready 	F29	Failure in indoor EEPROM		
	Operation Timer Ready 	H01	Compressor breakdown	Outdoor unit compressor related trouble
		H02	Compressor lockup	
		H03	Current detection circuit trouble	
H04		Comp. 1 case thermostat operation	Protective shutdown of outdoor unit	
H05		Wiring / installation trouble or detachment of outdoor discharge temperature sensor (TD1)		
H06		Abnormal drop in low-pressure sensor (Ps) reading	Protective shutdown of outdoor unit	
H07		Abnormal drop in oil level		
H08		Trouble in temperature sensor for oil level detection circuit (TK1, TK2, TK3, TK4 or TK5)		
F14		Comp. 2 case thermostat operation		
H15		Wiring / installation trouble or detachment of outdoor discharge temperature sensor (TD2)		
H16		Oil level detection circuit trouble - Trouble in outdoor unit TK1, TK2, TK3, TK4 or TK5 circuit		
H25		Wiring / installation trouble or detachment of outdoor discharge temperature sensor (TD3)		
Operation Timer Ready 		L02	Model mismatched of indoor and outdoor unit	
		L03	Duplicated indoor group header unit	
		L05	Duplicated priority indoor unit (as displayed on priority indoor unit)	
		L06	Duplicated priority indoor unit (as displayed on indoor unit other than priority indoor unit)	
	L07	Connection of group control cable to a single indoor unit		
	L08	Indoor group address not set		
	L09	Indoor capacity not set		
	Operation Timer Ready 	L04	Duplicated outdoor refrigerant line address	
		L10	Outdoor capacity not set	
L17		Outdoor model incompatibility trouble		
L18		Flow selector units trouble		
L20		Duplicated central control address		
L28		Too many outdoor units connected		
L29		Trouble in number of P.C. boards		
L30		Indoor external interlock trouble (External abnormal input)		

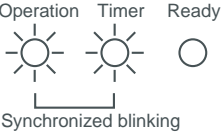
Light block	Check code	Cause of trouble
Operation Timer Ready 	F30	Occupancy sensor trouble
	F31	Outdoor EEPROM trouble

Other (indications not involving check code)

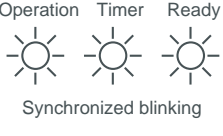
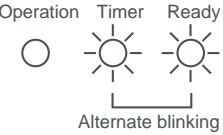
Light block	Check code	Cause of trouble
Operation Timer Ready 	–	Test run in progress
Operation Timer Ready 	–	Setting incompatibility (automatic cooling / heating setting for model incapable of it and heating setting for cooling-only model)

Flow selector unit (FS unit) Relation

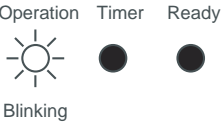
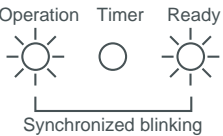
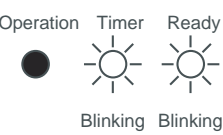
Light block	Check code	Cause of trouble
Operation Timer Ready 	E17	Communication trouble between indoor unit(s) and FS unit(s)
Operation Timer Ready 	L12	FS unit(s) system trouble
	L24	FS unit(s) setting trouble
Operation Timer Ready 	J03	Duplicated FS units
	J10	FS unit overflow trouble
	J11	FS unit temperature sensor(TCS) trouble

10-4. Check Codes Displayed on Remote Controller and SMMS series Outdoor Unit (7-Segment Display on I/F Board) and Locations to Be Checked

For other types of outdoor units, refer to their own service manuals.

Main remote controller	Check code		Location of detection	Description	System status	Check code detection condition(s)	Check items (locations)
	Outdoor 7-segment display						
	Check code	Sub-code					
E01	—	—	Remote controller	Indoor-remote controller communication trouble (detected at remote controller end)	Stop of corresponding unit	Communication between indoor P.C. board and remote controller is disrupted.	<ul style="list-style-type: none"> • Check remote controller inter-unit tie cable (A/B). • Check for broken wire or connector bad contact. • Check indoor power supply. • Check for failure in indoor P.C. board. • Check remote controller address settings (when two remote controllers are in use). • Check remote controller P.C. board.
E02	—	—	Remote controller	Remote controller transmission trouble	Stop of corresponding unit	Signal cannot be transmitted from remote controller to indoor unit.	<ul style="list-style-type: none"> • Check internal transmission circuit of remote controller. --- Replace remote controller as necessary.
E03	—	—	Indoor unit	Indoor-remote controller communication trouble (detected at indoor end)	Stop of corresponding unit	There is no communication from remote controller (including wireless) or network adaptor.	<ul style="list-style-type: none"> • Check remote controller and network adaptor wiring.
E04	—	—	Indoor unit	Indoor-outdoor communication circuit trouble (detected at indoor end)	Stop of corresponding unit	Indoor unit is not receiving signal from outdoor unit.	<ul style="list-style-type: none"> • Check order in which power was turned on for indoor and outdoor units. • Check indoor address setting. • Check indoor-outdoor tie cable. • Check outdoor terminator resistor setting (SW100, Bit 2).
E04	E06	No. of indoor units from which signal is received normally	I/F	Dropping out of indoor unit	All stop	<p>Condition 1 All indoor unit initially communicating normally fails to return signal for specified length of time.</p> <p>Condition 2 Outdoor I / F board SW103, Bit4 : OFF (Factory default)</p>	<ul style="list-style-type: none"> • Check power supply to indoor unit. (Is power turned on?) • Check connection of indoor-outdoor communication cable. • Check connection of communication connectors on indoor P.C. board. • Check connection of communication connectors on outdoor P.C. board. • Check for failure in indoor P.C. board. • Check for failure in outdoor P.C. board (I/F).
	—	—	Indoor unit	Indoor-outdoor communication circuit trouble	Only specified indoor units stop	<p>Condition 1 Indoor unit initially communicating normally fails to return signal for specified length of time.</p>	<ul style="list-style-type: none"> • Check power supply to indoor unit. (Is power turned on?) • Check indoor-outdoor power-on sequence. • Check indoor address setting • Check wiring of Indoor-outdoor communication wires • Check outdoor terminator resistor setting (SW100, Bit 2).

Main remote controller	Check code		Location of detection	Description	System status	Check code detection condition(s)	Check items (locations)
	Outdoor 7-segment display						
	Check code	Sub-code					
E04/E06	E06	No. of indoor units from which signal is received normally	Indoor unit	Indoor-outdoor communication circuit trouble (E04)	All stop	<p>Condition 1 One indoor unit or more initially communicating normally fails to return signal for specified length of time.</p> <p>Condition 2 Outdoor I / F board SW103, Bit4 : ON (To switch the check code detection condition.)</p>  <p>SW103</p>	<ul style="list-style-type: none"> • Check power supply to indoor unit. (Is power turned on?) • Check indoor-outdoor power-on sequence. • Check indoor address setting • Check wiring of Indoor-outdoor communication wires • Check outdoor terminator resistor setting (SW100, Bit 2).
			I/F	Dropping out of indoor unit (E06)			
—	E07	—	I/F	Indoor-outdoor communication circuit trouble (detected at outdoor end)	All stop	Signal cannot be transmitted from outdoor to indoor units for 30 seconds continuously.	<ul style="list-style-type: none"> • Check outdoor terminator resistor setting (SW100, Bit 2). • Check connection of indoor-outdoor communication circuit.
E08	E08	Duplicated indoor address	Indoor unit I/F	Duplicated indoor address	All stop	More than one indoor unit are assigned same address.	<ul style="list-style-type: none"> • Check indoor addresses. • Check for any change made to remote controller connection (group/ individual) since indoor address setting.
E09	—	—	Remote controller	Duplicated master remote controller	Stop of corresponding unit	In two remote controller configuration (including wireless), both controllers are set up as master. (Header indoor unit is shut down with alarm, while follower indoor units continue operating.)	<ul style="list-style-type: none"> • Check remote controller settings. • Check remote controller P.C. boards.
E10	—	—	Indoor unit	Indoor inter-MCU communication trouble	Stop of corresponding unit	Communication cannot be established/maintained upon turning on of power or during communication.	<ul style="list-style-type: none"> • Check for failure in indoor P.C. board
E12	E12	01: Indoor-outdoor communication 02: Outdoor-outdoor communication	I/F	Automatic address starting trouble	All stop	<ul style="list-style-type: none"> • Indoor automatic address setting is started while automatic address setting for equipment in other refrigerant line is in progress. • Outdoor automatic address setting is started while automatic address setting for indoor units is in progress. 	<ul style="list-style-type: none"> • Check whether the outdoor unit of other systems or the indoor unit is connected to Uv (U1/U2) line or Uc (U5/U6) line. • Perform automatic address setting again after disconnecting communication cable to that refrigerant line.
E15	E15	—	I/F	Indoor unit not found during automatic address setting	All stop	Indoor unit cannot be detected after indoor automatic address setting is started.	<ul style="list-style-type: none"> • Check connection of indoor-outdoor communication line. • Check for trouble in indoor power supply system. • Check for noise from other devices. • Check for power failure. • Check for failure in indoor P.C. board.

Main remote controller	Check code		Location of detection	Description	System status	Check code detection condition(s)	Check items (locations)
	Outdoor 7-segment display						
	Check code	Sub-code					
E16	E16	00: Capacity over 01-: No. of units connected	I/F	Too many indoor units connected	All stop	<ul style="list-style-type: none"> Combined capacity of indoor units is too large. <p>Note: If this code comes up after backup setting for outdoor unit failure is performed, perform "No capacity over detected" setting.</p> <p><"No capacity over detected" setting method> Turn on SW103 / Bit 3 on I/F P.C. board of outdoor header unit.</p> <p>For Cooling Only model, this check code is not displayed even if it exceeds the combined capacity of indoor units.</p> <ul style="list-style-type: none"> More than 128 indoor units are connected. 	<ul style="list-style-type: none"> Check capacities of indoor units connected. Check combined HP capacities of indoor units. Check HP capacity settings of outdoor units. Check No. of indoor units connected. Check for failure in outdoor P.C. board (I/F).
E18	—	—	Indoor unit	Trouble in communication between indoor header and follower units	Stop of corresponding unit	<p>Periodic communication between indoor header and follower units cannot be maintained.</p>	<ul style="list-style-type: none"> Check remote controller wiring. Check indoor power supply wiring. Check P.C. boards of indoor units.
E19	E19	00: No header unit 02: Two or more header units	I/F	Trouble in number of outdoor header units	All stop	<ul style="list-style-type: none"> There are more than one outdoor header units in one line. There is no outdoor header unit in one line. 	<p>The outdoor unit which turned on SW101 and the bit 1 of the interface P.C. board is set to Header unit.</p> <ul style="list-style-type: none"> Check SW101 bit 1 of follower outdoor unit. Check connection of indoor-outdoor communication line. Check for failure in outdoor P.C. board (I/F).
E20	E20	01: Connection of outdoor unit from other line 02: Connection of indoor unit from other line	I/F	Connection to other line found during automatic address setting	All stop	<p>Equipment from other line is found to have been connected when indoor automatic address setting is in progress.</p>	<p>Check whether the outdoor unit of other systems or the indoor unit is connected to Uv (U1/U2) line or Uc (U5/U6) line.</p>
E23	E23	—	I/F	Outdoor/outdoor communication transmission trouble	All stop	<p>Signal cannot be transmitted to other outdoor units for at least 30 seconds continuously.</p>	<ul style="list-style-type: none"> Check power supply to outdoor units. (Is power turned on?) Check connection of tie cables between outdoor units for bad contact or broken wire. Check communication connectors on outdoor P.C. boards. Check for failure in outdoor P.C. board (I/F). Check termination resistance setting for communication between outdoor units.
E25	E25	—	I/F	Duplicated follower outdoor address	All stop	<p>There is duplication in outdoor addresses set manually.</p>	<p>Note: Do not set outdoor addresses manually.</p>
E26	E26	Address of outdoor unit from which signal is not received normally	I/F	Signal lack of outdoor unit	All stop	<p>Outdoor unit initially communicating normally fails to return signal for specified length of time.</p>	<ul style="list-style-type: none"> Backup setting is being used for outdoor units. Check power supply to outdoor unit. (Is power turned on?) Check connection of tie cables between outdoor units for bad contact or broken wire. Check communication connectors on outdoor P.C. boards. Check for failure in outdoor P.C. board (I/F).

Check code			Location of detection	Description	System status	Check code detection condition(s)	Check items (locations)																																																																								
Main remote controller	Outdoor 7-segment display																																																																														
	Check code	Sub-code																																																																													
The check code which occurred follower outdoor unit is displayed	E28	Detected outdoor unit No.	I/F	Outdoor follower unit trouble	All stop	Outdoor header unit receives trouble code from outdoor follower unit.	<ul style="list-style-type: none"> Check check code displayed on outdoor follower unit. <Convenient functions> If SW04 is pressed and held for at least 1 second while [E28] is displayed on the 7-segment display of outdoor header unit, the fan of the outdoor unit that has been shut down due to a trouble comes on. If SW04 and SW05 are pressed simultaneously, the fans of normal outdoor units come on. To stop the fan or fans, press SW05 on its own.																																																																								
E31	E31	<table border="1"> <thead> <tr> <th colspan="4">P.C.board</th> </tr> <tr> <th colspan="2">Compressor</th> <th colspan="2">Fan Motor</th> </tr> <tr> <th>1</th> <th>2</th> <th>1</th> <th>2</th> </tr> </thead> <tbody> <tr><td>01</td><td>○</td><td></td><td></td></tr> <tr><td>02</td><td></td><td>○</td><td></td></tr> <tr><td>03</td><td>○</td><td>○</td><td></td></tr> <tr><td>08</td><td></td><td></td><td>○</td></tr> <tr><td>09</td><td>○</td><td></td><td>○</td></tr> <tr><td>0A</td><td></td><td>○</td><td>○</td></tr> <tr><td>0B</td><td>○</td><td>○</td><td>○</td></tr> <tr><td>10</td><td></td><td></td><td>○</td></tr> <tr><td>11</td><td>○</td><td></td><td>○</td></tr> <tr><td>12</td><td></td><td>○</td><td>○</td></tr> <tr><td>13</td><td>○</td><td>○</td><td>○</td></tr> <tr><td>18</td><td></td><td></td><td>○</td></tr> <tr><td>19</td><td>○</td><td></td><td>○</td></tr> <tr><td>1A</td><td></td><td>○</td><td>○</td></tr> <tr><td>1B</td><td>○</td><td>○</td><td>○</td></tr> </tbody> </table> Circle (O): Trouble P.C. board	P.C.board				Compressor		Fan Motor		1	2	1	2	01	○			02		○		03	○	○		08			○	09	○		○	0A		○	○	0B	○	○	○	10			○	11	○		○	12		○	○	13	○	○	○	18			○	19	○		○	1A		○	○	1B	○	○	○	I/F	P.C. board communication trouble	All stop	Communication is disrupted between P.C. board in inverter box.	<ul style="list-style-type: none"> Check wiring and connectors involved in communication between P.C. board I/F P.C. board for bad contact or broken wire. Check for failure in outdoor P.C. board (I/F, comp. P.C. board or Fan P.C. board). Check for external noise.
		P.C.board																																																																													
Compressor		Fan Motor																																																																													
1	2	1	2																																																																												
01	○																																																																														
02		○																																																																													
03	○	○																																																																													
08			○																																																																												
09	○		○																																																																												
0A		○	○																																																																												
0B	○	○	○																																																																												
10			○																																																																												
11	○		○																																																																												
12		○	○																																																																												
13	○	○	○																																																																												
18			○																																																																												
19	○		○																																																																												
1A		○	○																																																																												
1B	○	○	○																																																																												
		80		Communication trouble between MCU and Sub MCU	All stop	Communication between MCU and Sub MCU stopped.	<ul style="list-style-type: none"> Operation of power supply reset (OFF for 60 seconds or more) Outdoor I/F PC board trouble check 																																																																								
F01	—	—	Indoor unit	Indoor TCJ sensor trouble	Stop of corresponding unit	Sensor resistance is infinity or zero (open/short circuit).	<ul style="list-style-type: none"> Check connection of TCJ sensor connector and wiring. Check resistance characteristics of TCJ sensor. Check for failure in indoor P.C. board. 																																																																								
F02	—	—	Indoor unit	Indoor TC2 sensor trouble	Stop of corresponding unit	Sensor resistance is infinity or zero (open/short circuit).	<ul style="list-style-type: none"> Check connection of TC2 sensor connector and wiring. Check resistance characteristics of TC2 sensor. Check for failure in indoor P.C. board. 																																																																								
F03	—	—	Indoor unit	Indoor TC1 sensor trouble	Stop of corresponding unit	Sensor resistance is infinity or zero (open/short circuit).	<ul style="list-style-type: none"> Check connection of TC1 sensor connector and wiring. Check resistance characteristics of TC1 sensor. Check for failure in indoor P.C. board. 																																																																								
F04	F04	—	I/F	TD1 sensor trouble	All stop	Sensor resistance is infinity or zero (open/short circuit).	<ul style="list-style-type: none"> Check connection of TD1 sensor connector. Check resistance characteristics of TD1 sensor. Check for failure in outdoor P.C. board (I/F). 																																																																								

Main remote controller	Check code		Location of detection	Description	System status	Check code detection condition(s)	Check items (locations)
	Outdoor 7-segment display						
	Check code	Sub-code					
F05	F05	—	I/F	TD2 sensor trouble	All stop	Sensor resistance is infinity or zero (open/short circuit).	<ul style="list-style-type: none"> • Check connection of TD2 sensor connector. • Check resistance characteristics of TD2 sensor. • Check for failure in outdoor P.C. board (I/F).
F06	F06	01: TE1 sensor trouble 02: TE2 sensor trouble 03: TE3 sensor trouble	I/F	TE1/TE2/TE3 sensor trouble	All stop	Sensor resistance is infinity or zero (open/short circuit).	<ul style="list-style-type: none"> • Check connection of TE1/TE2/TE3 sensor connectors. • Check resistance characteristics of TE1/TE2/TE3 sensors. • Check for failure in outdoor P.C. board (I/F).
F07	F07	01: TL1 sensor trouble 02: TL2 sensor trouble 03: TL3 sensor trouble	I/F	TL1/TL2/TL3 sensor trouble	All stop	Sensor resistance is infinity or zero (open/short circuit).	<ul style="list-style-type: none"> • Check connection of TL1/TL2/TL3 sensor connector. • Check resistance characteristics of TL1/TL2/TL3 sensor. • Check for failure in outdoor P.C. board (I/F).
F08	F08	—	I/F	TO sensor trouble	All stop	Sensor resistance is infinity or zero (open/short circuit).	<ul style="list-style-type: none"> • Check connection of TO sensor connector. • Check resistance characteristics of TO sensor. • Check for failure in outdoor P.C. board (I/F).
F09	F09	01: TG1 sensor trouble 02: TG2 sensor trouble 03: TG3 sensor trouble	I/F	TG1/TG2/TG3 sensor trouble	All stop	Sensor resistance is infinity or zero (open/short circuit).	<ul style="list-style-type: none"> • Check connection of TG1/TG2/TG3 sensor connectors. • Check resistance characteristics of TG1/TG2/TG3 sensors. • Check for failure in outdoor P.C. board (I/F).
F10	—	—	Indoor unit	Indoor TA sensor trouble	Stop of corresponding unit	Sensor resistance is infinity or zero (open/short circuit).	<ul style="list-style-type: none"> • Check connection of TA sensor connector and wiring. • Check resistance characteristics of TA sensor. • Check for failure in indoor P.C. board.
F11	—	—	Indoor unit	Indoor TF sensor trouble	Stop of corresponding unit	Sensor resistance is infinity or zero (open/short circuit).	<ul style="list-style-type: none"> • Check connection of TF sensor connector and wiring. • Check resistance characteristics of TF sensor. • Check for failure in indoor P.C. board.
F12	F12	01: TS1 sensor trouble 03: TS3 sensor trouble	I/F	TS1/TS3 sensor trouble	All stop	Sensor resistance is infinity or zero (open/short circuit).	<ul style="list-style-type: none"> • Check connection of TS1/TS3 sensor connector • Check resistance characteristics of TS1/TS3 sensor. • Check for failure in indoor P.C. board.
F13	F13	1☒ Compressor 1 side 2☒ Compressor 2 side	Compressor P.C. board	TH sensor trouble	All stop	Sensor resistance is infinity or zero (open/short circuit).	<ul style="list-style-type: none"> • Failure in IPM built-in temperature sensor → Replace Compressor P.C. board.
F15	F15	—	I/F	Outdoor temperature sensor wiring trouble (TE1, TL1)	All stop	During compressor operation in HEAT mode, TL1 continuously provides temperature reading higher than indicated by TL1 by at least specified margin for 3 minutes or more.	<ul style="list-style-type: none"> • Check installation of TE1 and TL1 sensors. • Check resistance characteristics of TE1 and TL1 sensors. • Check for outdoor P.C. board (I/F) trouble

Main remote controller	Check code		Location of detection	Description	System status	Check code detection condition(s)	Check items (locations)
	Outdoor 7-segment display						
	Check code	Sub-code					
F16	F16	—	I/F	Outdoor pressure sensor wiring trouble (Pd, Ps)	All stop	Readings of high-pressure Pd sensor and low-pressure Ps sensor are switched. Output voltages of both sensors are zero.	<ul style="list-style-type: none"> • Check connection of high-pressure Pd sensor connector. • Check connection of low-pressure Ps sensor connector. • Check for failure in pressure sensors Pd and Ps. • Check for trouble in outdoor P.C. board (I/F). • Check for compressor poor compression.
F23	F23	—	I/F	Ps sensor trouble	All stop	Output voltage of Ps sensor is zero.	<ul style="list-style-type: none"> • Check for connection trouble involving Ps sensor and Pd sensor connectors. • Check connection of Ps sensor connector. • Check for failure in Ps sensor. • Check for compressor poor compression. • Check for failure in 4-way valve. • Check for failure in outdoor P.C. board (I/F). • Check for failure in SV4 circuit.
F24	F24	—	I/F	Pd sensor trouble	All stop	Output voltage of Pd sensor is zero (sensor open-circuited). Pd > 4.15MPa despite compressor having been turned off.	<ul style="list-style-type: none"> • Check connection of Pd sensor connector. • Check for failure in Pd sensor. • Check for failure in outdoor P.C. board (I/F).
F29	—	—	Indoor unit	Other indoor trouble	Stop of corresponding unit	Indoor P.C. board does not operate normally.	<ul style="list-style-type: none"> • Check for failure in indoor P.C. board (failure EEPROM)
F31	F31	—	I/F	Outdoor EEPROM trouble	All stop *1	Outdoor P.C. board (I/F) does not operate normally.	<ul style="list-style-type: none"> • Check power supply voltage. • Check power supply noise. • Check for failure in outdoor P.C. board (I/F).
H01	H01	1 <input checked="" type="checkbox"/> Compressor 1 side 2 <input checked="" type="checkbox"/> Compressor 2 side	Compressor P.C. board	Compressor breakdown	All stop	Inverter current detection circuit detects overcurrent and shuts system down.	<ul style="list-style-type: none"> • Check power supply voltage. (AC380V-415V ± 10%). • Check for failure in compressor. • Check for possible cause of abnormal overloading. • Check for failure in outdoor P.C. board (Compressor).
H02	H02	1 <input checked="" type="checkbox"/> Compressor 1 side 2 <input checked="" type="checkbox"/> Compressor 2 side	Compressor P.C. board	Compressor trouble (lockup) MG-CTT trouble	All stop	Overcurrent is detected several seconds after startup of inverter compressor.	<ul style="list-style-type: none"> • Check for failure in compressor. • Check power supply voltage. (AC380V-415V ± 10%). • Check compressor system wiring, particularly for open phase. • Check connection of connectors/terminals on compressor P.C. board. • Check conductivity of case heater. (Check for refrigerant problem inside compressor.) • Check for failure in outdoor P.C. board (Compressor). • Check outdoor MG-CTT.
H03	H03	1 <input checked="" type="checkbox"/> Compressor 1 side 2 <input checked="" type="checkbox"/> Compressor 2 side	Compressor P.C. board	Current detection circuit trouble	All stop	Current flow of at least specified magnitude is detected despite inverter compressor having been shut turned off.	<ul style="list-style-type: none"> • Check current detection circuit wiring. • Check failure in outdoor P.C. board (Compressor).

*1 Total shutdown in case of header unit
Continued operation in case of follower unit

Main remote controller	Check code		Location of detection	Description	System status	Check code detection condition(s)	Check items (locations)
	Outdoor 7-segment display						
	Check code	Sub-code					
H05	H05	—	I/F	TD1 sensor miswiring (incomplete insertion)	All stop	Discharge temperature of compressor 1 (TD1) does not increase despite compressor being in operation.	<ul style="list-style-type: none"> • Check installation of TD1 sensor. • Check connection of TD1 sensor connector and wiring. • Check resistance characteristics of TD1 sensor. • Check for failure in outdoor P.C. board (I/F).
H06	H06	—	I/F	Activation of low-pressure protection	All stop	Low-pressure Ps sensor detects operating pressure lower than 0.02MPa.	<ul style="list-style-type: none"> • Check service valves to confirm full opening (both gas and liquid sides). • Check outdoor PMVs for clogging (PMV1, 2, 3). • Check for failure in SV4 circuits. • Check for failure in low-pressure Ps sensor. • Check indoor filter for clogging. • Check valve opening status of indoor PMV. • Check refrigerant piping for clogging. • Check operation of outdoor fan (during heating). • Check for insufficiency in refrigerant quantity.
H07	H07	—	I/F	Low oil level protection	All stop	Operating compressor detects continuous state of low oil level for about 2 hours.	<p><All outdoor units in corresponding line to be checked></p> <ul style="list-style-type: none"> • Check connection and installation of TK1 and TK2 sensors. • Check resistance characteristics of TK1 and TK2 sensors. • Check for gas or oil leak in same line. • Check for refrigerant problem inside compressor casing. • Check SV3D, SV3F valves for failure. • Check oil return circuit of oil separator for clogging. • Check oil equalizing circuit for clogging.
H08	H08	01: TK1 sensor trouble 02: TK2 sensor trouble	I/F	Trouble in temperature sensor for oil level detection	All stop	Sensor resistance is infinity or zero (open/short circuit).	<ul style="list-style-type: none"> • Check connection of TK1 sensor connector. • Check resistance characteristics of TK1 sensor. • Check for failure in outdoor P.C. board (I/F).
					All stop	Sensor resistance is infinity or zero (open/short circuit).	<ul style="list-style-type: none"> • Check connection of TK2 sensor connector. • Check resistance characteristics of TK2 sensor. • Check for failure in outdoor P.C. board (I/F).
H15	H15	—	I/F	TD2 sensor miswiring (incomplete insertion)	All stop	Discharge temperature of (TD2) does not increase despite compressor 2 being in operation.	<ul style="list-style-type: none"> • Check installation of TD2 sensor. • Check connection of TD2 sensor connector and wiring. • Check resistance characteristics of TD2 sensor. • Check for failure in outdoor P.C. board (I/F).

Main remote controller	Check code		Location of detection	Description	System status	Check code detection condition(s)	Check items (locations)
	Outdoor 7-segment display						
	Check code	Sub-code					
H16	H16	01: TK1 oil circuit trouble 02: TK2 oil circuit trouble	I/F	Oil level detection circuit trouble	All stop	No temperature change is detected by TK1 despite compressor 1 having been started.	<ul style="list-style-type: none"> • Check for disconnection of TK1 sensor. • Check resistance characteristics of TK1 sensor. • Check for connection trouble involving TK1 and TK2 sensors • Check for clogging in oil equalizing circuit capillary. • Check for refrigerant entrapment inside compressor.
						No temperature change is detected by TK2 despite compressor 2 having been started.	<ul style="list-style-type: none"> • Check for disconnection of TK2 sensor. • Check resistance characteristics of TK2 sensor. • Check for connection trouble involving TK1 and TK2 sensors • Check SV3F valve malfunction. • Check for clogging in oil equalizing circuit capillary. • Check for refrigerant entrapment inside compressor.
H17	H17	<input checked="" type="checkbox"/> Compressor 1 side <input checked="" type="checkbox"/> Compressor 2 side	Compressor P.C. board	Compressor trouble (Step-out)	All stop	Judged that the synchronization could not be taken.	<ul style="list-style-type: none"> • Check power supply voltage. (AC380V-415V ± 10%). • Check for failure in compressor. • Check for possible cause of abnormal overloading. • Check for failure in outdoor P.C. board (compressor).
L02	L02	—	Indoor unit	Outdoor units model disagreement trouble	Stop of corresponding unit	In case of different outdoor unit (Not corresponded to Air to Air Heat Exchanger type)	<ul style="list-style-type: none"> • Check outdoor unit model. (Check whether the outdoor unit corresponds to Air to Air Heat Exchanger type or not.)
L03	—	—	Indoor unit	Duplicated indoor header unit	Stop of corresponding unit	There are more than one header units in group.	<ul style="list-style-type: none"> • Check indoor addresses. • Check for any change made to remote controller connection (group/individual) since indoor address setting.
L04	L04	—	I/F	Duplicated outdoor line address	All stop	There is duplication in line address setting for outdoor units belonging to different refrigerant piping systems.	<ul style="list-style-type: none"> • Check line addresses.
L05	—	—	I/F	Duplicated priority indoor unit (as displayed on priority indoor unit)	All stop	More than one indoor units have been set up as priority indoor unit.	<ul style="list-style-type: none"> • Check display on priority indoor unit.
L06	L06	No. of priority indoor units	I/F	Duplicated priority indoor unit (as displayed on indoor unit other than priority indoor unit)	All stop	More than one indoor units have been set up as priority indoor unit.	<ul style="list-style-type: none"> • Check displays on priority indoor unit and outdoor unit.
L07	—	—	Indoor unit	Connection of group control cable to standalone indoor unit	Stop of corresponding unit	There is at least one standalone indoor unit to which group control cable is connected.	<ul style="list-style-type: none"> • Check indoor addresses.
L08	L08	—	Indoor unit	Indoor group / addresses not set	Stop of corresponding unit	Address setting has not been performed for indoor units.	<ul style="list-style-type: none"> • Check indoor addresses. <p>Note: This code is displayed when power is turned on for the first time after installation.</p>
L09	—	—	Indoor unit	Indoor capacity not set	Stop of corresponding unit	Capacity setting has not been performed for indoor unit.	Set indoor capacity. (DN = 11)

Check code			Location of detection	Description	System status	Check code detection condition(s)	Check items (locations)																																																																								
Main remote controller	Outdoor 7-segment display																																																																														
	Check code	Sub-code																																																																													
L10	L10	—	I/F	Outdoor capacity not set	All stop	Initial setting of I/F P.C. board has not been implemented.	• Check model setting of P.C. board for servicing outdoor I/F P.C. board.																																																																								
L20	—	—	Network adaptor Indoor unit	Duplicated central control address	All stop	There is duplication in central control address setting.	• Check central control addresses.																																																																								
L23	—	—	I/F	SW setting mistake	All stop	Outdoor P.C. board (I/F) does not operate normally.	• Check switch setting of outdoor P.C. board (I/F).																																																																								
L28	L28	—	I/F	Too many outdoor units connected	All stop	There are more than 5 outdoor units.	• Check No. of outdoor units connected (Only up to 5 units per system allowed). • Check communication lines between outdoor units. • Check for failure in outdoor P.C. board (I/F).																																																																								
L29	L29	<table border="1"> <thead> <tr> <th colspan="4">P.C. board</th> </tr> <tr> <th colspan="2">Compressor</th> <th colspan="2">Fan Motor</th> </tr> <tr> <th>1</th> <th>2</th> <th>1</th> <th>2</th> </tr> </thead> <tbody> <tr><td>01</td><td>○</td><td></td><td></td></tr> <tr><td>02</td><td></td><td>○</td><td></td></tr> <tr><td>03</td><td>○</td><td>○</td><td></td></tr> <tr><td>08</td><td></td><td></td><td>○</td></tr> <tr><td>09</td><td>○</td><td></td><td>○</td></tr> <tr><td>0A</td><td></td><td>○</td><td>○</td></tr> <tr><td>0B</td><td>○</td><td>○</td><td>○</td></tr> <tr><td>10</td><td></td><td></td><td>○</td></tr> <tr><td>11</td><td>○</td><td></td><td>○</td></tr> <tr><td>12</td><td></td><td>○</td><td>○</td></tr> <tr><td>13</td><td>○</td><td>○</td><td>○</td></tr> <tr><td>18</td><td></td><td></td><td>○</td></tr> <tr><td>19</td><td>○</td><td></td><td>○</td></tr> <tr><td>1A</td><td></td><td>○</td><td>○</td></tr> <tr><td>1B</td><td>○</td><td>○</td><td>○</td></tr> </tbody> </table> <p>Circle (○): Trouble P.C. board</p>	P.C. board				Compressor		Fan Motor		1	2	1	2	01	○			02		○		03	○	○		08			○	09	○		○	0A		○	○	0B	○	○	○	10			○	11	○		○	12		○	○	13	○	○	○	18			○	19	○		○	1A		○	○	1B	○	○	○	I/F	Trouble in No. of P.C. board	All stop	Insufficient number of P.C. board are detected when power is turned on.	• Check model setting of P.C. board for servicing outdoor I/F P.C. board. • Check connection of UART communication connector. • Check compressor P.C. board, fan P.C. board, and I/F P.C. board for failure.
		P.C. board																																																																													
Compressor		Fan Motor																																																																													
1	2	1	2																																																																												
01	○																																																																														
02		○																																																																													
03	○	○																																																																													
08			○																																																																												
09	○		○																																																																												
0A		○	○																																																																												
0B	○	○	○																																																																												
10			○																																																																												
11	○		○																																																																												
12		○	○																																																																												
13	○	○	○																																																																												
18			○																																																																												
19	○		○																																																																												
1A		○	○																																																																												
1B	○	○	○																																																																												
00			I/F	The number of inverter P.C. boards is abnormal.	All stop	When there is much number of an inverter P.C. board to model setting of an interface P.C. board.	• Check I/F P.C. board exchange has been correctly performed as a procedure. • Check for failure in I/F P.C. board. • Check for inverter P.C. board for compressors and inverter P.C. board for fan.																																																																								
L30	L30	Detected indoor address	Indoor unit	Indoor external interlock (External abnormal input)	Stop of corresponding unit	• Indoor unit has been shut down due to external abnormal input signal.	When external device is connected: 1) Check for trouble in external device. 2) Check for trouble in indoor P.C. board. When external device is not connected: 1) Check for trouble in indoor P.C. board.																																																																								
—	L31	—	I/F	Extended IC trouble	Continued operation	There is part failure in P.C. board (I/F).	Check outdoor P.C. board (I/F).																																																																								
P01	—	—	Indoor unit	Indoor fan motor trouble	Stop of corresponding unit		• Check the lock of fan motor (AC fan). • Check wiring.																																																																								
P03	P03	—	I/F	Discharge temperature TD1 trouble	All stop	Discharge temperature (TD1) exceeds 115 °C.	• Check outdoor service valves (gas side, liquid side) to confirm full opening. • Check outdoor PMVs (PMV1, 2, 3, 4) for clogging. • Check resistance characteristics of TD1 sensor. • Check for insufficiency in refrigerant quantity. • Check for failure in 4-way valve. • Check for leakage of SV4 circuit. • Check SV4 circuit (wiring or installation trouble in SV41 or SV42).																																																																								

Main remote controller	Check code		Location of detection	Description	System status	Check code detection condition(s)	Check items (locations)
	Outdoor 7-segment display						
	Check code	Sub-code					
P04	P04	1 <input checked="" type="checkbox"/> Compressor 1 side 2 <input checked="" type="checkbox"/> Compressor 2 side	I/F	Activation of high-pressure SW	All stop	High-pressure SW is activated.	<ul style="list-style-type: none"> • Check connection of high-pressure SW connector. • Check for failure in Pd pressure sensor. • Check outdoor service valves (gas side, liquid side) to confirm full opening. • Check for failure in outdoor fan. • Check for failure in outdoor fan motor. • Check outdoor PMVs (PMV1, 2, 3) for clogging. • Check indoor/outdoor heat exchangers for clogging. • Check for short-circuiting of outdoor suction/discharge air flows. • Check for failure in outdoor P.C. board (I/F). • Check for trouble in indoor fan system (possible cause of air flow reduction). • Check opening status of indoor PMV. • Check indoor-outdoor communication line for wiring trouble. • Check for failure operation of check valve in discharge pipe convergent section. • Check gas balancing SV4 valve circuit. • Check for refrigerant overcharging.
P05	P05	00: Power detection trouble 01: Open phase 02: Power supply miswiring 1 <input checked="" type="checkbox"/> Compressor 1 side 2 <input checked="" type="checkbox"/> Compressor 2 side	I/F Compressor P.C. board	Power detection trouble / Open phase detection / Power supply miswiring Compressor Vdc trouble	All stop	<ul style="list-style-type: none"> • Open phase is detected when power is turned on. • Inverter DC voltage is too high (overvoltage) or too low (undervoltage). 	<ul style="list-style-type: none"> • Check for failure in outdoor P.C. board (I/F). • Check wiring of outdoor power supply. • Check power supply voltage.
P07	P07	1 <input checked="" type="checkbox"/> Compressor 1 side 2 <input checked="" type="checkbox"/> Compressor 2 side 01: Compressor 1 heat sink trouble 02: Compressor 2 heat sink trouble 04: Heat sink dew condensation	Compressor P.C. board I/F	Heat sink overheating trouble Heat sink overheating trouble Heat sink dew condensation trouble	All stop All stop	Temperature sensor built into IPM (TH) is overheated. Condensation detection on heat sink has occurred four times or more in operation. Temperature sensor built into IPM (TH) is overheated.	<ul style="list-style-type: none"> • Check outdoor fan system trouble. • Check IPM and heat sink for thermal performance for failure installation. (e.g. mounting screws and thermal conductivity) • Check for failure in Compressor P.C. board. (failure IPM built-in temperature sensor (TH)) • Check outdoor fan system trouble. • Check IPM and heat sink for thermal performance for troubled installation. (e. g. mounting screws and thermal conductivity) • Check for failure in compressor P.C. board. (failure IPM built-in temperature sensor (TH)) • Check shortage of refrigerant. • Check outdoor service valves. • Check connection of TL2 sensor. • Check resistance characteristics of TL2 sensor. • Check resistance characteristics of TO sensor. • Check malfunctions of Pd and Ps sensors. • Check outdoor I/F P.C. board malfunction. • Check PMV2 and PMV3

Main remote controller	Check code		Location of detection	Description	System status	Check code detection condition(s)	Check items (locations)
	Outdoor 7-segment display						
	Check code	Sub-code					
P10	P10	Detected indoor address	Indoor unit	Indoor overflow trouble	All stop	<ul style="list-style-type: none"> • Float switch operates. • Float switch circuit is open-circuited or disconnected at connector. 	<ul style="list-style-type: none"> • Check float switch connector. • Check operation of drain pump. • Check drain pump circuit. • Check drain pipe for clogging. • Check for failure in indoor P.C. board.
P11	—	—	I/F	Outdoor heat exchanger freeze trouble	All stop	<ul style="list-style-type: none"> • Outdoor heat exchanger remaining frost detection has occurred eight times or more due to abnormal frost formation in heating operation. 	<ul style="list-style-type: none"> • Check shortage of refrigerant. • Check connection of TE1, TE2 and TE3 sensors. • Check resistance characteristics of TE1, TE2, and TE3 sensors. • Check disconnection of TS1 sensor. • Check resistance characteristics of TS1 sensor. • Check outdoor I/F P.C. board malfunction. • Check operation of 4 way valve. • Check operation of outdoor PMV (1, 2, 3). • Check short circuit from outlet air to inlet air.
P12	—	—	Indoor unit	Indoor fan motor trouble	Stop of corresponding unit	<ul style="list-style-type: none"> • Motor speed measurements continuously deviate from target value. • Overcurrent protection is activated. 	<ul style="list-style-type: none"> • Check connection of fan connector and wiring. • Check for failure in fan motor. • Check for failure in indoor P.C. board. • Check impact of outside air treatment (OA).
P13	P13	—	I/F	Outdoor liquid backflow detection trouble	All stop	<p><During cooling operation> When system is in cooling operation, high pressure is detected in the unit that has been turned off.</p> <p><During heating operation> When system is in heating operation, low pressure is detected to be high in unit that has been turned off.</p>	<ul style="list-style-type: none"> • Check full-close operation of outdoor PMV (1, 2, 3, 4). • Check for failure in Pd or Ps sensor. • Check failure in outdoor P.C. board (I/F). • Check capillary of oil separator oil return circuit for clogging. • Check for leakage of check valve in discharge pipe
P15	P15	01: TS condition	I/F	Gas leak detection (TS1 condition)	All stop	Protective shutdown due to sustained suction temperature at or above judgment criterion for at least 10 minutes is repeated four times or more. <TS trouble judgment criterion> In cooling operation: 60 °C In heating operation: 40 °C	<ul style="list-style-type: none"> • Check for insufficiency in refrigerant quantity. • Check outdoor service valves (gas side, liquid side) to confirm full opening. • Check PMVs (PMV1, 2, 3, 4) for clogging. • Check resistance characteristics of TS1 sensor. • Check for failure in 4-way valve. • Check SV4 circuit for leakage
		02: TD condition	I/F	Gas leak detection (TD condition)	All stop	Protective shutdown due to sustained discharge temperature (TD1 or TD2) at or above 108 °C for at least 10 minutes is repeated four times or more.	<ul style="list-style-type: none"> • Check for insufficiency in refrigerant quantity. • Check PMVs (PMV 1, 2, 3, 4) for clogging. • Check resistance characteristics of TD1 and TD2 sensors. • Check indoor filter for clogging. • Check piping for clogging. • Check SV4 circuit (for leakage or coil installation trouble).

Main remote controller	Check code		Location of detection	Description	System status	Check code detection condition(s)	Check items (locations)
	Outdoor 7-segment display						
	Check code	Sub-code					
P17	P17	—	I/F	Discharge temperature TD2 trouble	All stop	Discharge temperature (TD2) exceeds 115 °C.	<ul style="list-style-type: none"> • Check outdoor service valves (gas side, liquid side) to confirm full opening. • Check outdoor PMVs (PMV1, 2, 3, 4) for clogging. • Check resistance characteristics of TD2 sensor. • Check for failure in 4-way valve. • Check SV4 circuit for leakage. • Check SV4 circuit (for wiring or installation trouble involving SV41 and SV42).
P19	P19	Detected outdoor unit No.	I/F	4-way valve reversing trouble	All stop	Abnormal refrigerating cycle data is collected during heating operation.	<ul style="list-style-type: none"> • Check for failure in main body of 4-way valve. • Check for coil failure in 4-way valve and loose connection of its connector. • Check resistance characteristics of TS1 and TE1, TE2 sensors. • Check output voltage characteristics of Pd and Ps pressure sensors. • Check for wiring trouble involving TE1 and TL1 sensors.
P20	P20	—	I/F	Activation of high-pressure protection	All stop	<p><During cooling operation> Pd sensor detects pressure equal to or greater than 3.85 MPa.</p> <p><During heating operation> Pd sensor detects pressure equal to or greater than 3.6 MPa.</p>	<ul style="list-style-type: none"> • Check for failure in Pd pressure sensor. • Check service valves (gas side, liquid side) to confirm full opening. • Check for failure in outdoor fan. • Check for failure in outdoor fan motor. • Check outdoor PMV (PMV1, 2, 3, 4) for clogging. • Check indoor/outdoor heat exchangers for clogging. • Check for short-circuiting of outdoor suction/discharge air flows. • Check for failure in outdoor P.C. board (I/F). • Check for failure in indoor fan system (possible cause of air flow reduction). • Check opening status of indoor PMV. • Check indoor-outdoor communication line for wiring trouble. • Check for trouble operation of check valve in discharge pipe convergent section. • Check gas balancing SV4 valve circuit. • Check for refrigerant overcharging.

Check code			Location of detection	Description	System status	Check code detection condition(s)	Check items (locations)
Main remote controller	Outdoor 7-segment display						
	Check code	Sub-code					
P22	P22	1*: Fan P.C. board 1 2*: Fan P.C. board 2	Fan INV. P.C. board	Outdoor fan P.C. board trouble	All stop	Protected operation of Fan inverter P.C. board	<ul style="list-style-type: none"> • Check fan motor. • Check for failure in fan P.C. board. • Check connection of fan motor connector. • Check power voltage of the main power supply.
P26	P26	1*: Compressor 1 side 2*: Compressor 2 side	Compressor P.C. board	IPM, Compressor shortcircuit protection trouble	All stop	Overcurrent is momentarily detected during startup of compressor.	<ul style="list-style-type: none"> • Check connector connection and wiring on compressor P.C. board. • Check for failure in compressor (layer shortcircuit). • Check for failure in outdoor P.C. board (Compressor).
P29	P29	1*: Compressor 1 side 2*: Compressor 2 side	Compressor P.C. board	Compressor position detection circuit trouble	All stop	Position detection is not going on normally.	<ul style="list-style-type: none"> • Check wiring and connector connection. • Check for compressor layer short-circuit. • Check for failure in compressor P.C. board.
P31	—	—	Indoor unit	Other indoor trouble (group follower unit trouble)	Stop of corresponding unit	There is trouble in other indoor unit in group, resulting in detection of E07/L07/L03/L08.	<ul style="list-style-type: none"> • Check indoor P.C. board.

Check codes Detected by Central Control Device

Main remote controller	Check code		Location of detection	Description	System status	Check code detection condition(s)	Check items (locations)
	Outdoor 7-segment display	Sub-code					
C05	—		Central control device	Central control device transmission trouble	Continued operation	Central control device is unable to transmit signal.	<ul style="list-style-type: none"> • Check for failure in central control device. • Check for failure in central control communication line. • Check termination resistance setting.
C06	—		Central control device	Central control device reception trouble	Continued operation	Central control device is unable to receive signal.	<ul style="list-style-type: none"> • Check for failure in central control device. • Check for failure in central control communication line. • Check terminator resistor setting. • Check power supply for devices at other end of central control communication line. • Check failure in P.C. boards of devices at other end of central control communication line.
C12	—		General-purpose device I/F	Batch alarm for general-purpose device control interface	Continued operation	Trouble signal is input to control interface for general-purpose devices.	<ul style="list-style-type: none"> • Check trouble input.
P30	Differs according to nature of alarm-causing trouble		Central control device	Group control follower unit trouble	Continued operation	Trouble occurs in follower unit under group control. ([P30] is displayed on central control remote controller.)	<ul style="list-style-type: none"> • Check check code of unit that has generated alarm.
	(L20 displayed.)			Duplicated central control address	Continued operation	There is duplication in central control addresses.	<ul style="list-style-type: none"> • Check address settings.

▼ Points to Note When Servicing Compressor

(1) When checking the outputs of inverters, remove the wiring from all the compressors.

▼ How to Check Inverter Output

- (1) Turn off the power supply.
- (2) Remove compressor leads from the compressor P.C. board.
(The model with two compressor should remove the wiring for two sets (6 leads).)
- (3) Turn on the power supply and start cooling or heating operation.
- (4) Check the output voltage across each pair of inverter-side. If the result is unsatisfactory according to the judgment criteria given in the table below, replace the compressor P.C. board.

No.	Measured leads	Criterion
1	CN201 - CN202	380~580V
2	CN202 - CN203	380~580V
3	CN203 - CN201	380~580V

▼ How to Check Resistance of Compressor Winding

- (1) Turn off the power supply.
- (2) Remove compressor leads from the compressor P.C. board. (Be sure to remove all the leads.)
- (3) With each compressor, check the phase-to-phase winding resistances and winding-to-outdoor cabinet resistance using a multimeter.
 - Earth trouble?
→ It is normal if the winding-to-outdoor cabinet resistance is 10MΩ or more.
 - Inter-winding short circuit?
→ It is normal if the phase-to-phase resistances are in the 0.1-1.0Ω range. (Use a digital multimeter.)

▼ How to Check Outdoor Fan Motor

- (1) Turn off the power supply.
- (2) Remove fan motor leads from the fan P.C. board for the outdoor fan.
- (3) Rotate the fan by hand. If the fan does not turn, the fan motor is faulty (locked up). Replace the fan motor. If the fan turns, measure the phase-to-phase winding resistances using a multimeter. It is normal if the measurements are in the 8.1-9.9 range. (Use a digital multimeter.)

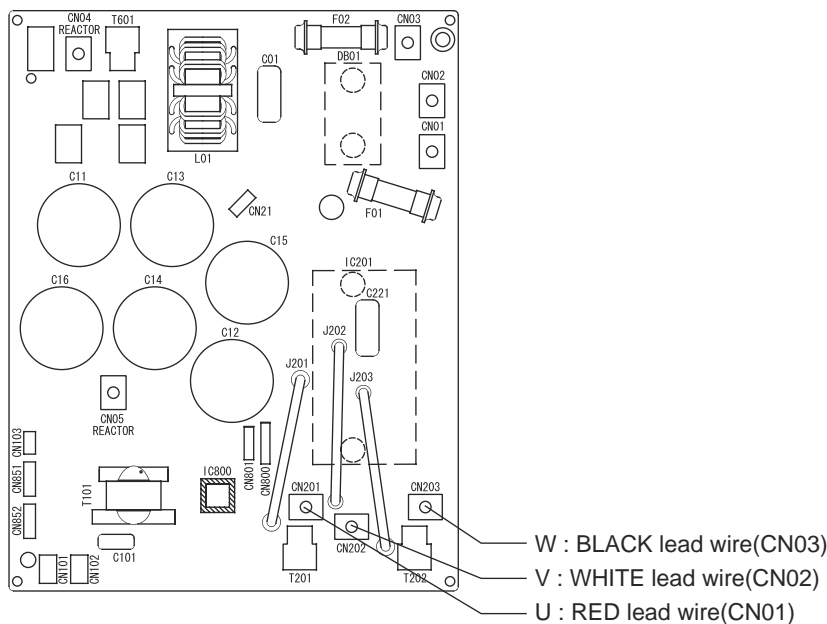

10-5. Diagnostic Procedure for Each Check Code (Indoor Unit)

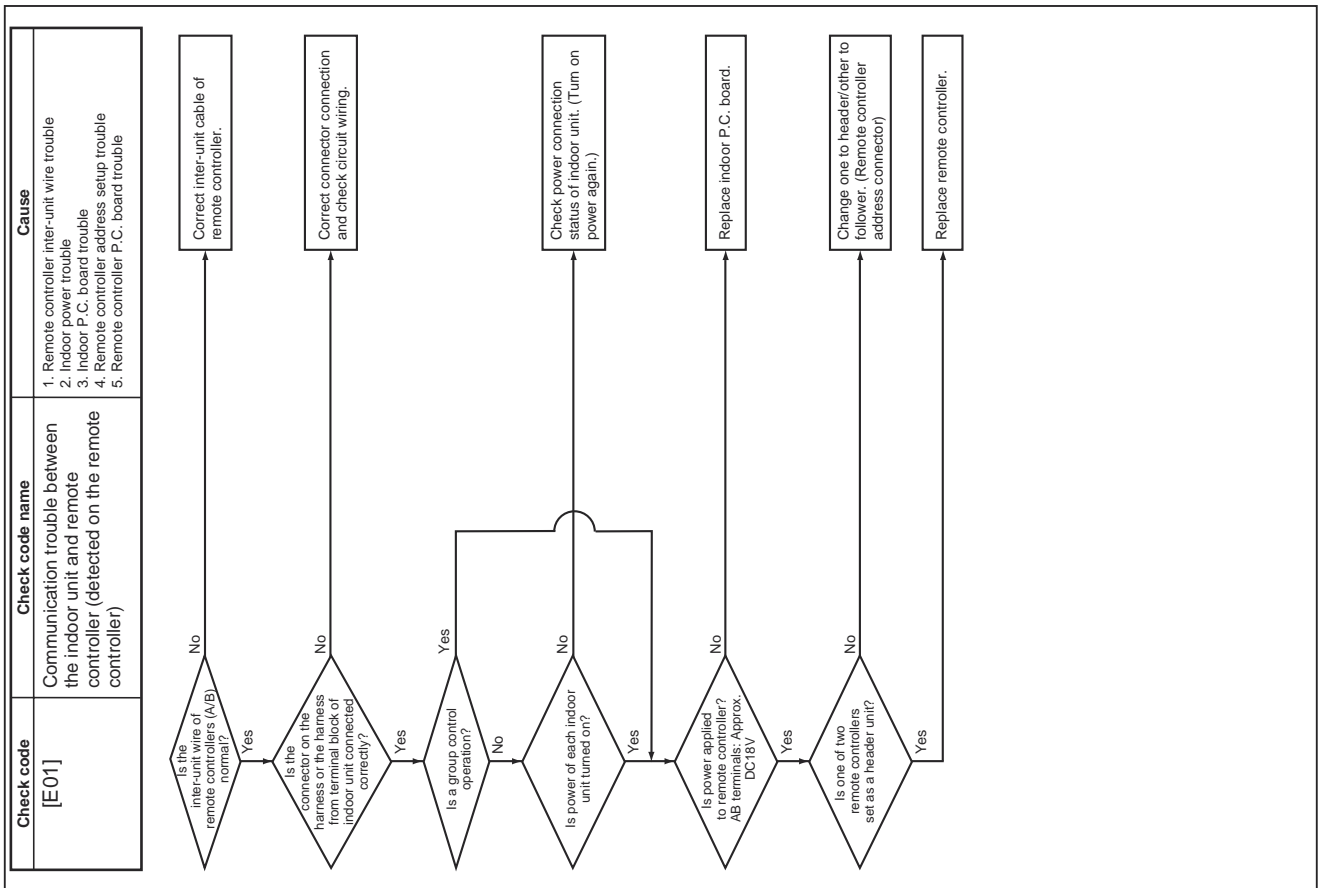
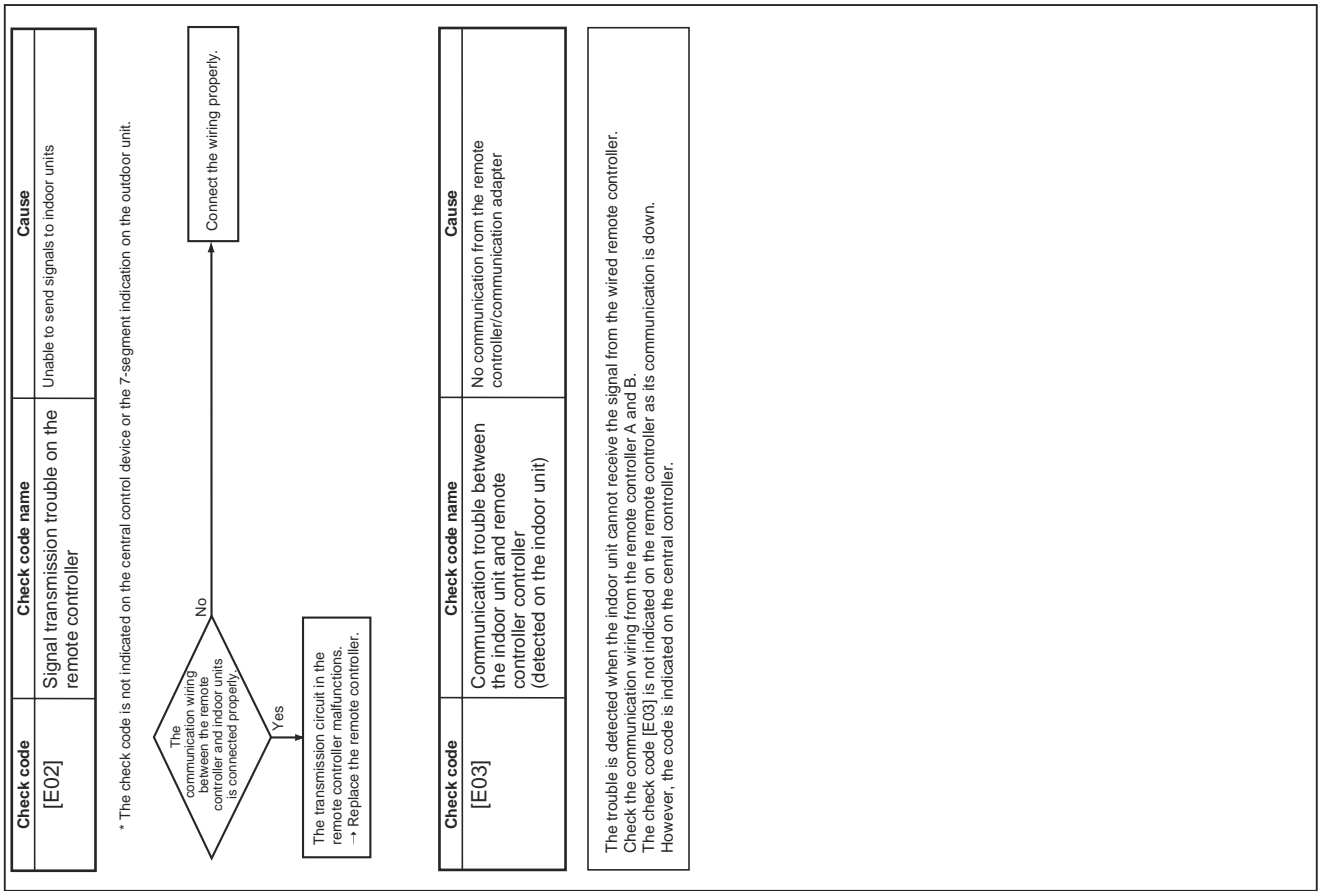

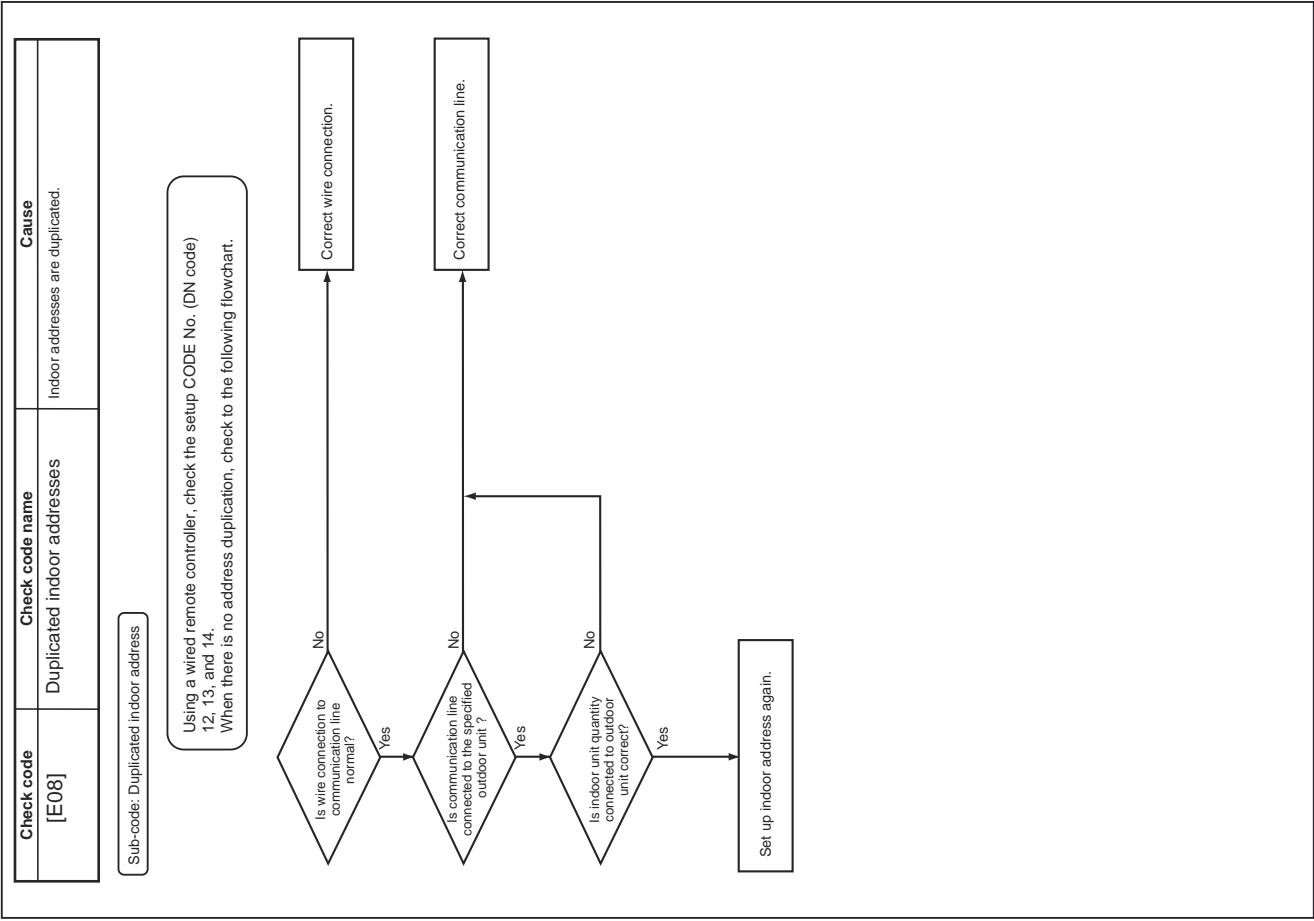
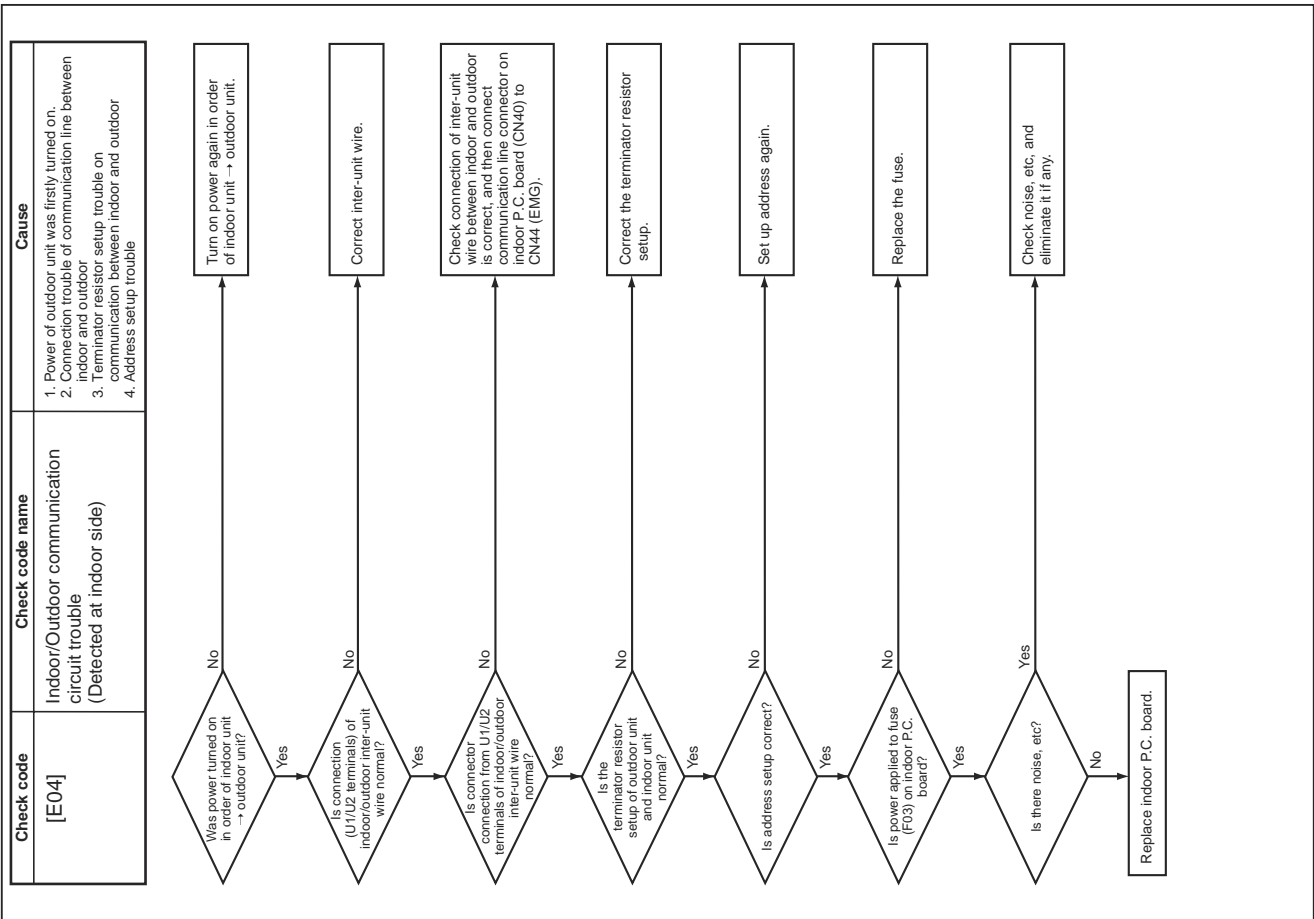

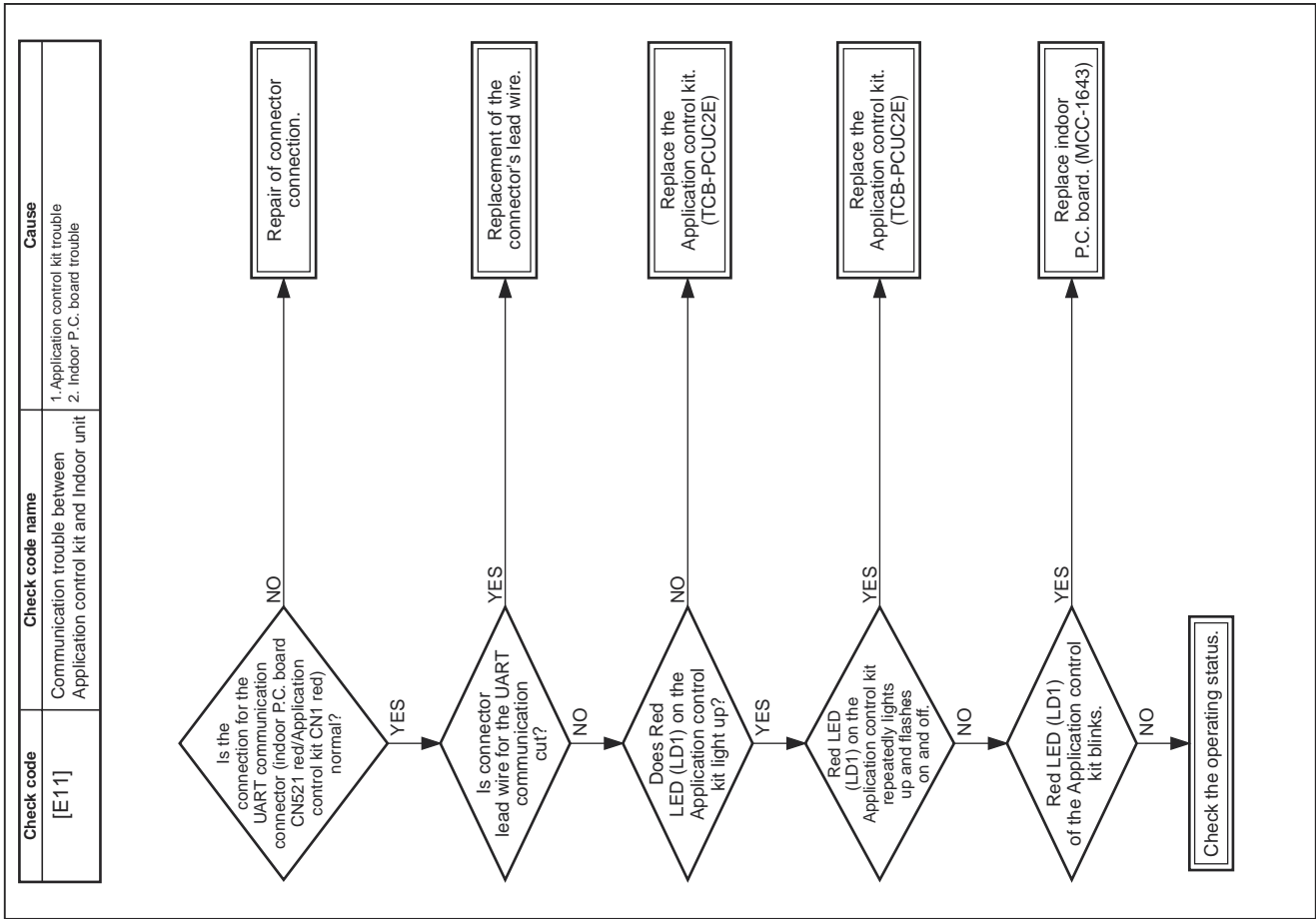
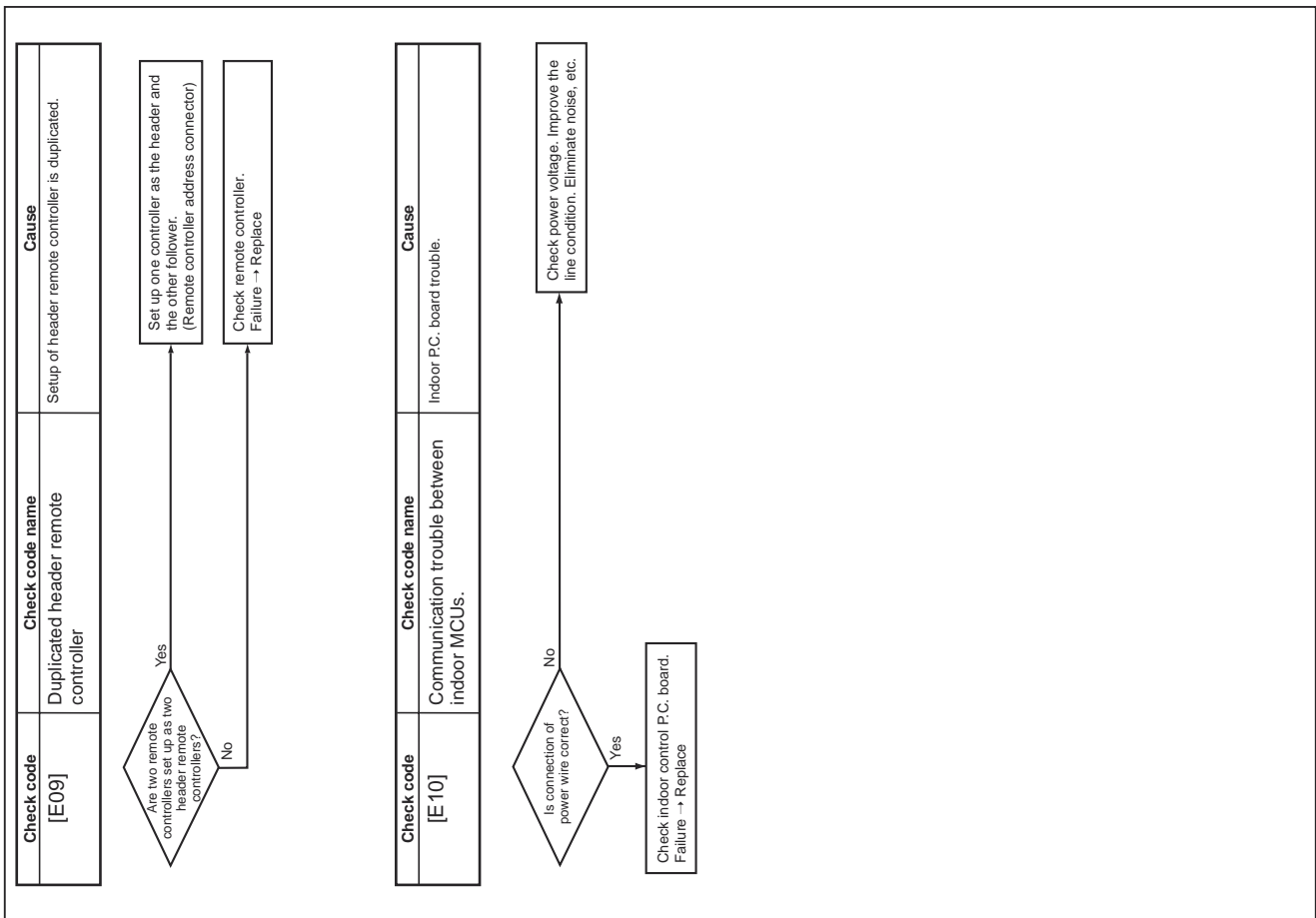

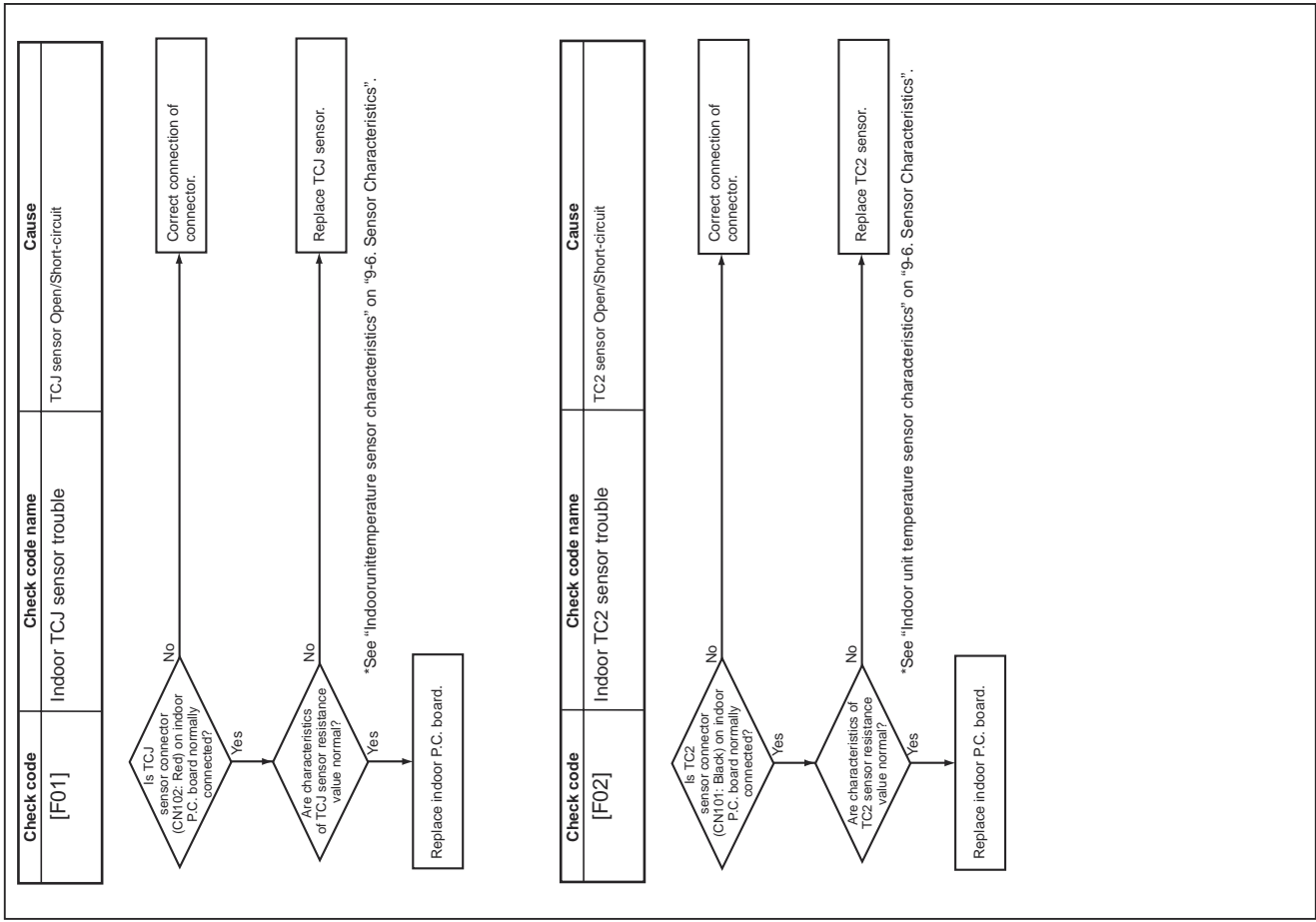
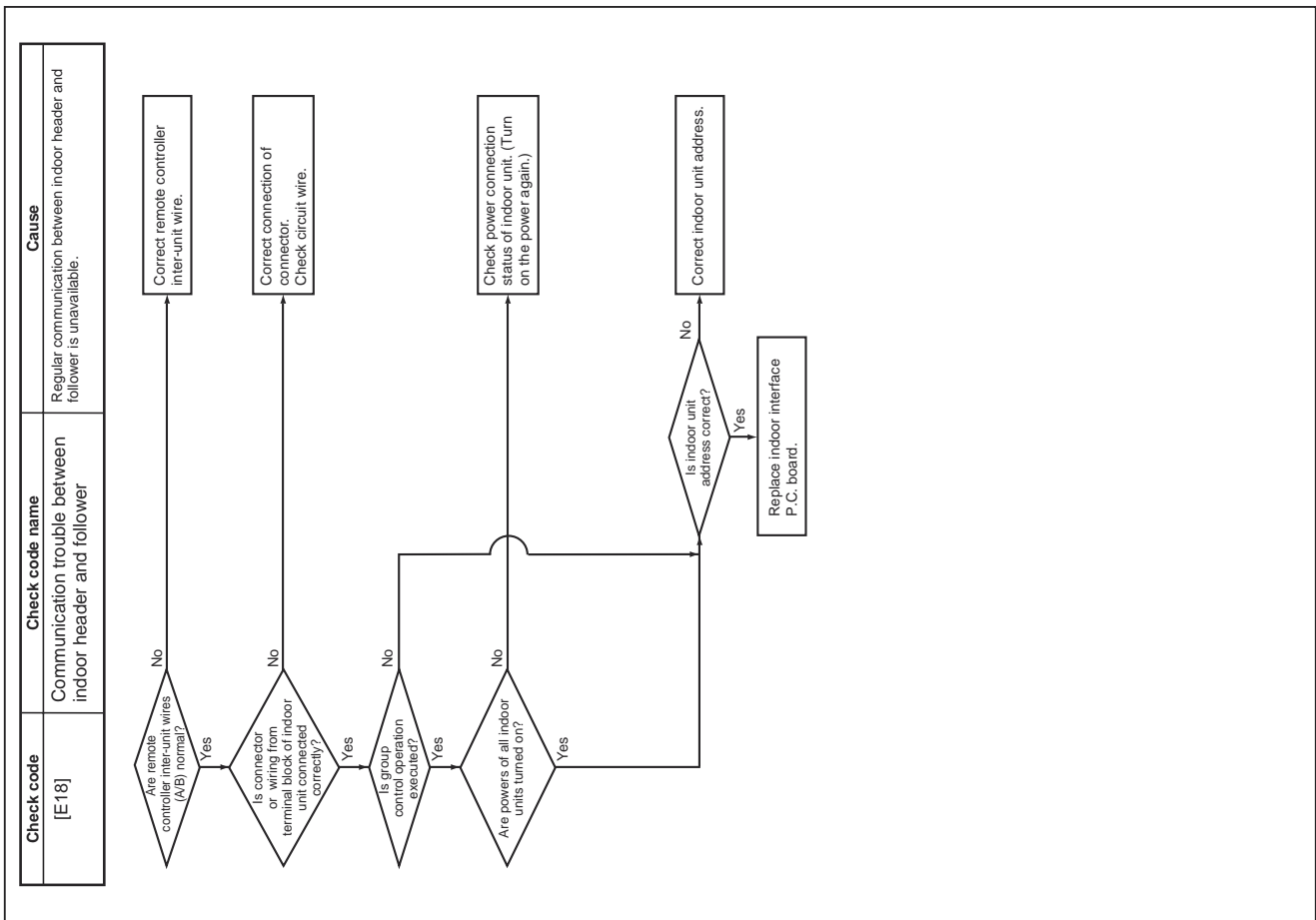

Check code	Check code name	Cause
[F03]	Indoor TC1 sensor trouble	TC1 sensor Open/Short-circuit

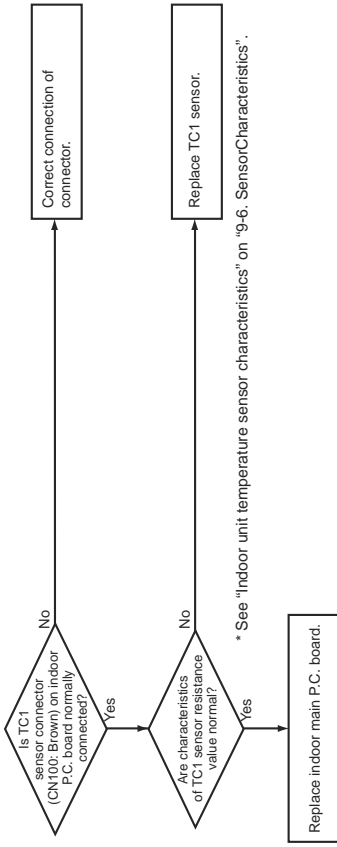

Check code	Check code name	Cause
[F10]	Indoor TA/TSA sensor trouble	TA sensor Open/Short-circuit

This trouble code means detection of Open/Short-circuit of TA sensor. Check disconnection of circuit for connection of connector (TA/TSA sensor : CN 104: Yellow) and characteristics of sensor resistance value. (See "Indoor unit temperature sensor characteristics" on "9-6. Sensor Characteristics".)
If sensor is normal, replace indoor P.C. board.

Check code	Check code name	Cause
[F29]	Indoor other trouble	Indoor P.C. board trouble

This trouble is detected during operation of air conditioner of IC10 non-volatile memory (EEPROM) on indoor unit P.C.board. Replace service P.C. board.

* If EEPROM was not inserted when power was turned on or it is absolutely impossible to read/write EEPROM data, the automatic address mode is repeated.

```

graph LR
    A["(Power ON)"] --> B["(Approx. 3 minutes)"]
    B --> C["(Approx. 1 minute)"]
    C --> D["LED (D02) 1Hz flashes for approx. 10 seconds on indoor unit P.C. board."]
    D --> E["Reboot (Reset)"]
    E --> A
    
```

(Repetition)

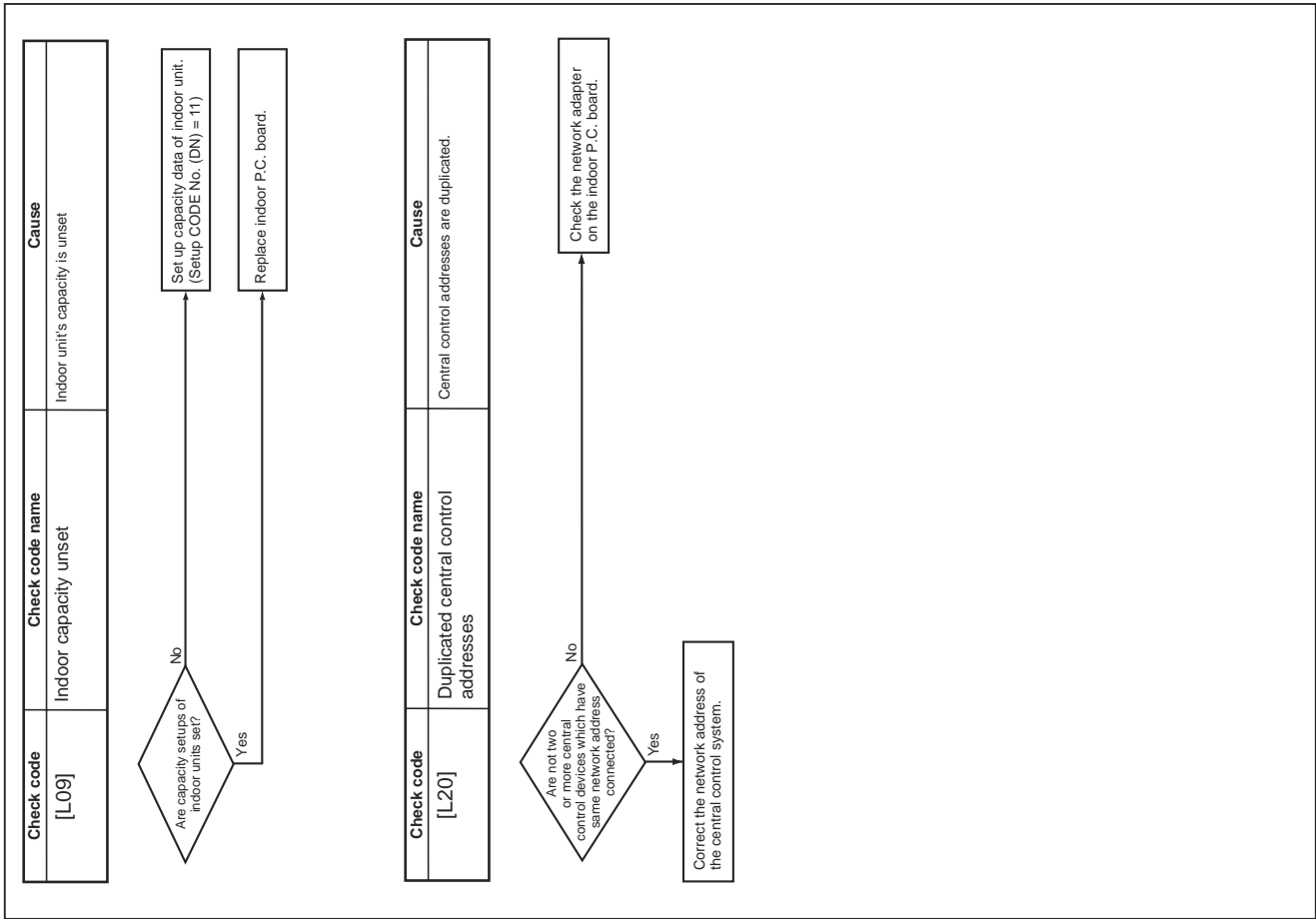
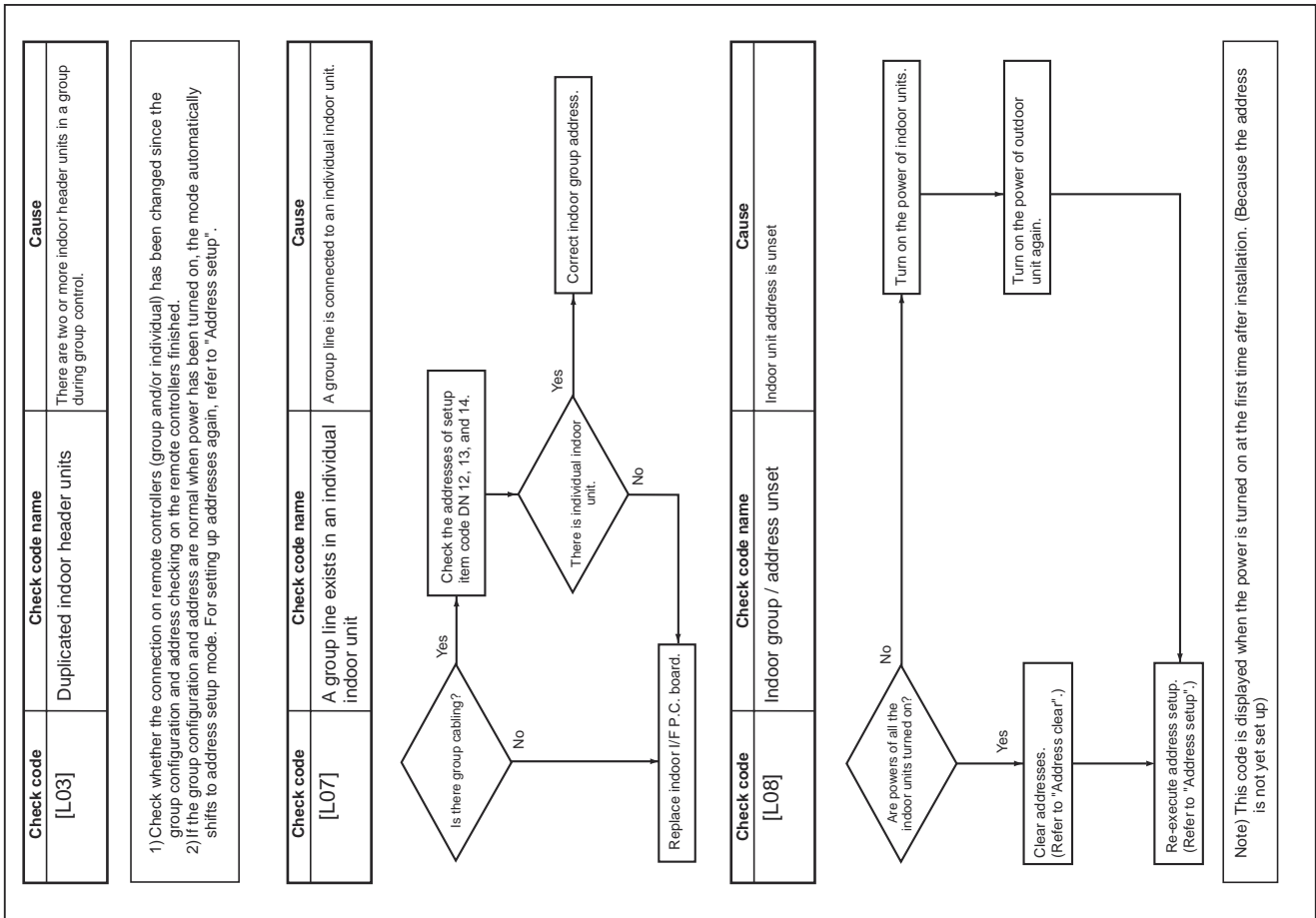

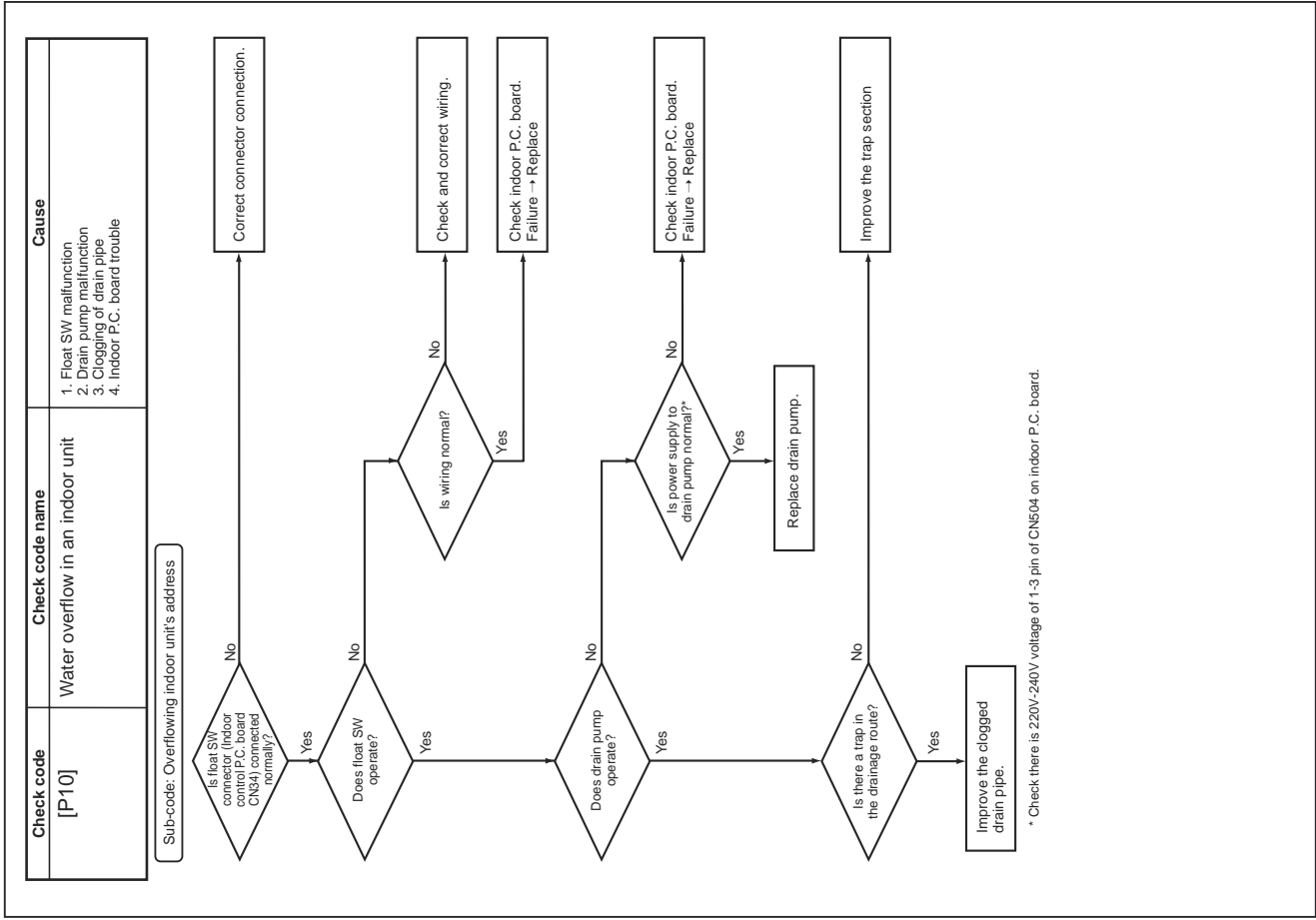
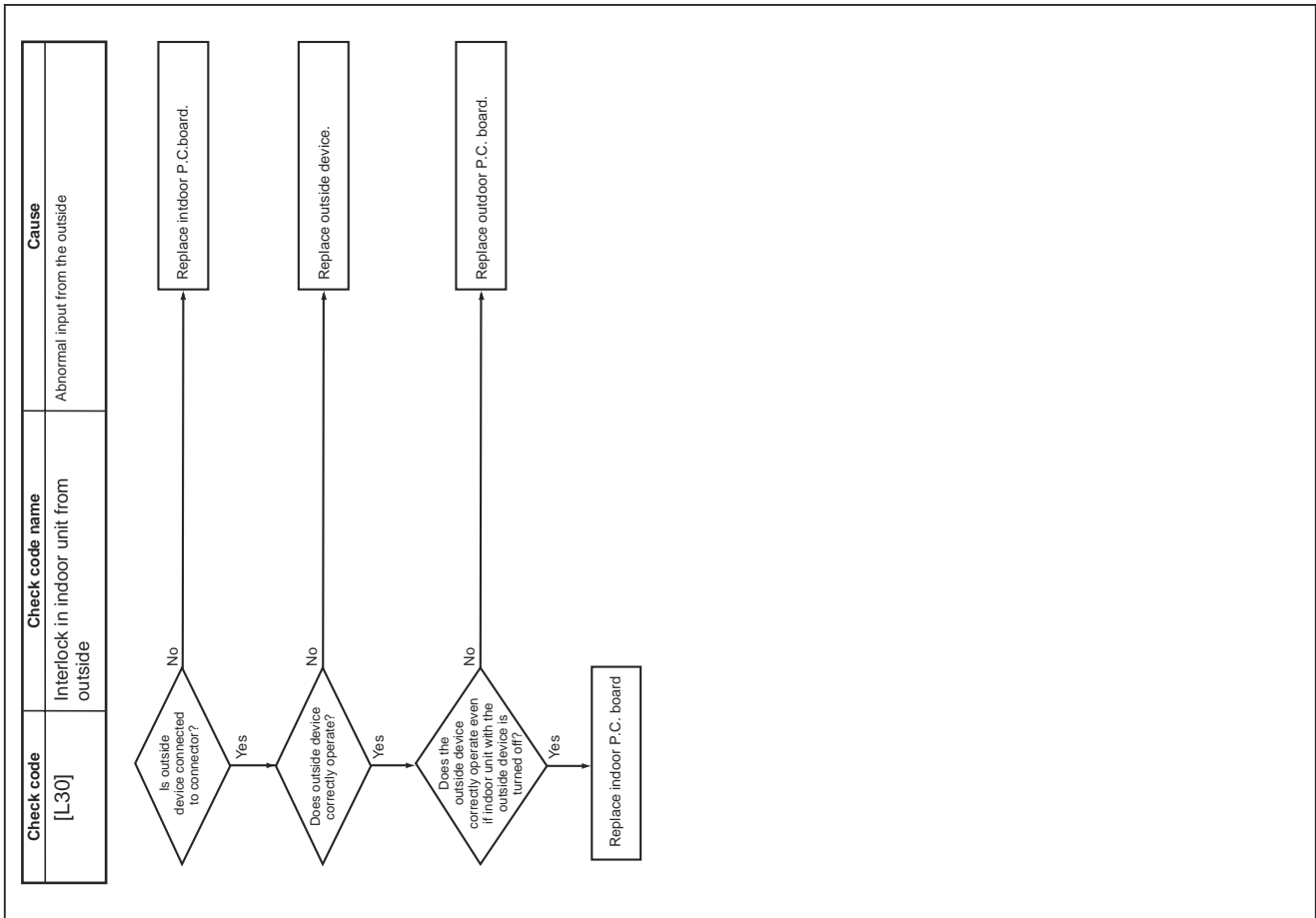

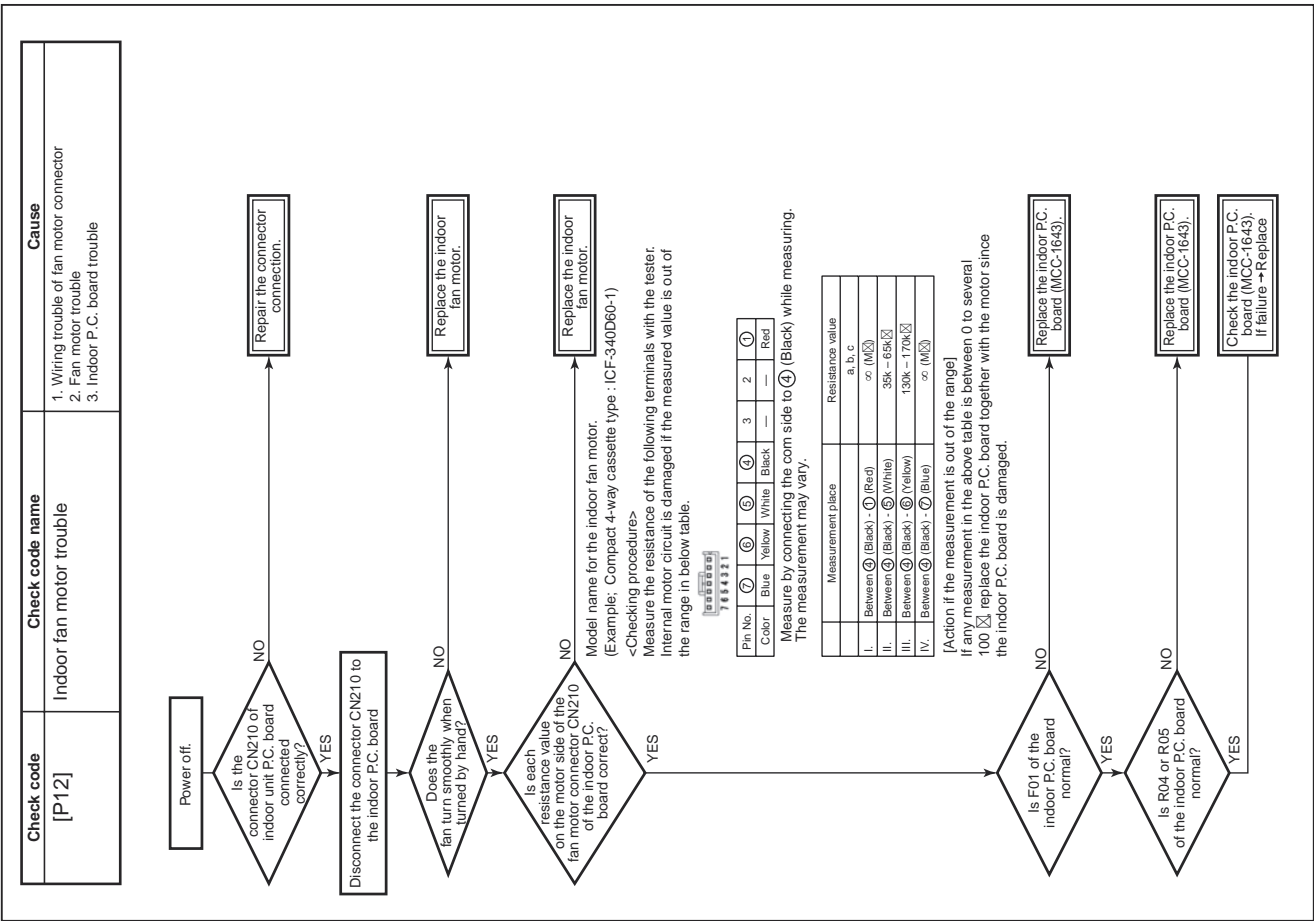

10-6. Sensor characteristics

Indoor unit

▼ Temperature sensor characteristics

Indoor TA sensor

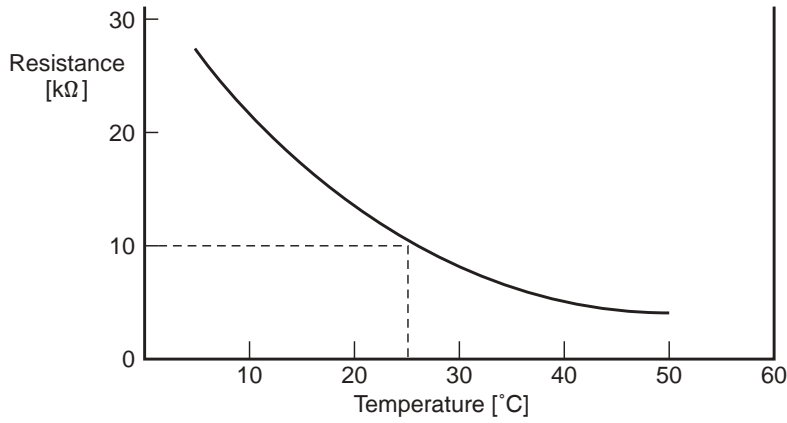

Temperature [°C]	Resistance [kΩ]
0	33.9
5	26.1
10	20.3
15	15.9
20	12.6
25	10.0
30	8.0
35	6.4
40	5.2
45	4.2
50	3.5
55	2.6
60	2.4

Indoor TC1 sensor

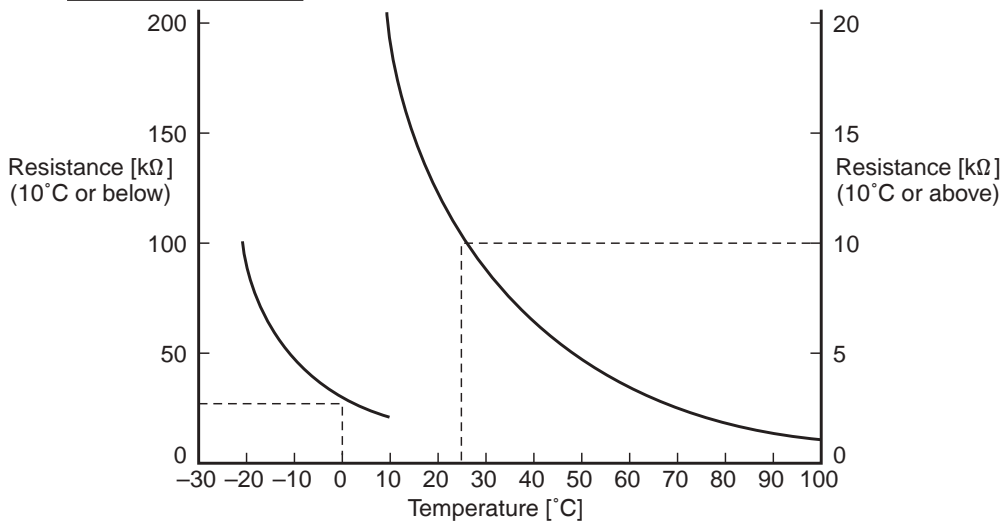

Temperature [°C]	Resistance [kΩ]
-20	99.9
-15	74.1
-10	55.6
-5	42.2
0	32.8
5	25.4
10	19.8
15	15.6
20	12.4
25	10.0
30	8.1
35	6.5
40	5.3
45	4.4
50	3.6
55	3.0
60	2.5
65	2.1
70	1.8
75	1.5
80	1.3
85	1.1
90	1.0
95	0.8
100	0.7

Indoor TC2 and TCJ sensors

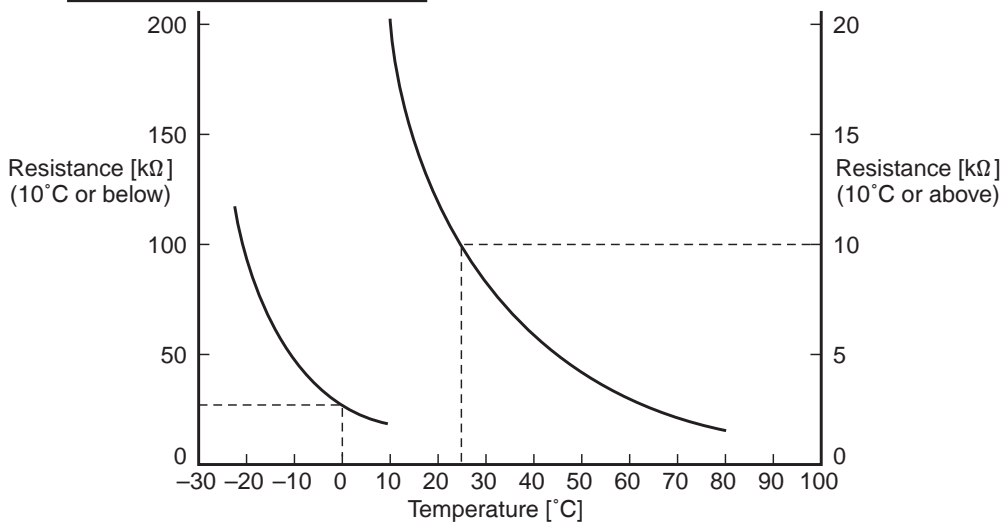

Temperature [°C]	Resistance [kΩ]
-20	115.2
-15	84.2
-10	62.3
-5	46.6
0	35.2
5	26.9
10	20.7
15	16.1
20	12.6
25	10.0
30	8.0
35	6.4
40	5.2
45	4.2
50	3.5
55	2.8
60	2.4
65	2.0
70	1.6
75	1.4
80	1.2

■ Precision metering valve (PMV) coil characteristics

Measured parts	Resistance values (at 20°C)
Red - White	180 ~ 220 Ω
Red - Yellow	180 ~ 220 Ω
Red - Orange	180 ~ 220 Ω
Red - Blue	180 ~ 220 Ω

<Maintenance/Check list>

Aiming in environmental preservation, it is strictly recommended to clean and maintain the indoor/outdoor units of the operating air conditioning system regularly to secure effective operation of the air conditioner.

It is also recommended to maintain the units once a year regularly when operating the air conditioner for a long time.

Check periodically signs of rust or scratches, etc. on coating of the outdoor units.

Repair the defective position or apply the rust resisting paint if necessary.

If an indoor unit operates for approx. 8 hours or more per day, usually it is necessary to clean the indoor/outdoor units once three months at least.

These cleaning and maintenance should be carried out by a qualified dealer.

Although the customer has to pay the charge for the maintenance, the life of the unit can be prolonged.

Failure to clean the indoor/outdoor units regularly will cause shortage of capacity, freezing, water leakage or trouble on the compressor.

Part name	Object		Contents of check	Contents of maintenance
	Indoor	Outdoor		
Heat exchanger	○	○	• Blocking with dust, damage check	• Clean it when blocking is found.
Fan motor	○	○	• Audibility for sound	• When abnormal sound is heard
Filter	○	—	• Visual check for dirt and breakage	• Clean with water if dirty • Replace if any breakage
Fan	○	○	• Visual check for swing and balance • Check adhesion of dust and external appearance.	• Replace fan when swinging or balance is remarkably poor. • If a large dust adheres, clean it with brush or water.
Drain pan	○	—	• Check blocking by dust and dirt of drain water.	• Clean drain pan, Inclination check
External appearance	—	○	• Check rust and peeling of insulator • Check peeling and floating of coating film	• Coating with repair painting

11. REPLACEMENT OF SERVICE P.C. BOARD

CAUTION

<Model name: MMD-UP***1SPHY*>

<Note: when replacing the P.C. board for indoor unit servicing>

The nonvolatile memory (hereafter called EEPROM, IC503) on the indoor unit P.C. board before replacement includes the model specific type information and capacity codes as the factory-set value and the important setting data which have been automatically or manually set when the indoor unit is installed, such as system/indoor/group addresses, high ceiling select setting, etc.

When replacing the P.C. board for indoor unit servicing, follow the procedures below.

After replacement completes, confirm whether the settings are correct by checking the indoor unit No., Group header unit/follower unit settings and perform the cooling cycle confirmation through the trial operation.

<Replacement procedures>

CASE 1

Before replacement, the indoor unit can be turned on and the setting data can be read out by wired remote control operation.

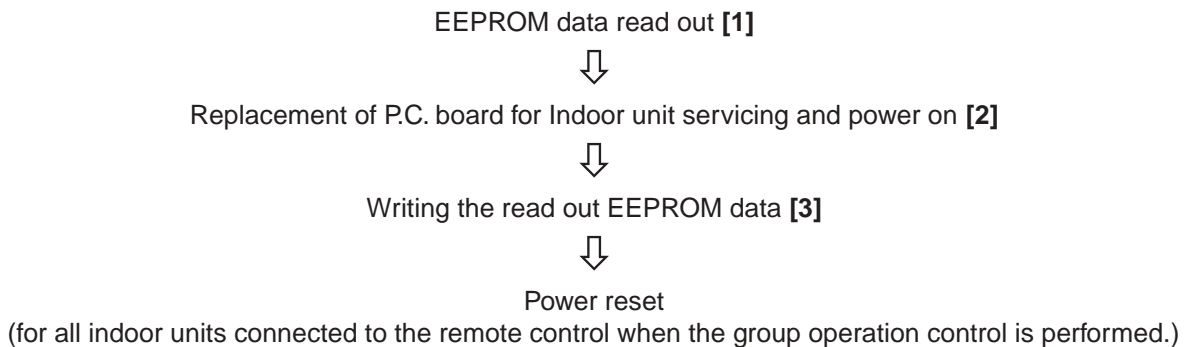

CASE 2

The EEPROM before replacement is defective and the setting data cannot be read out.

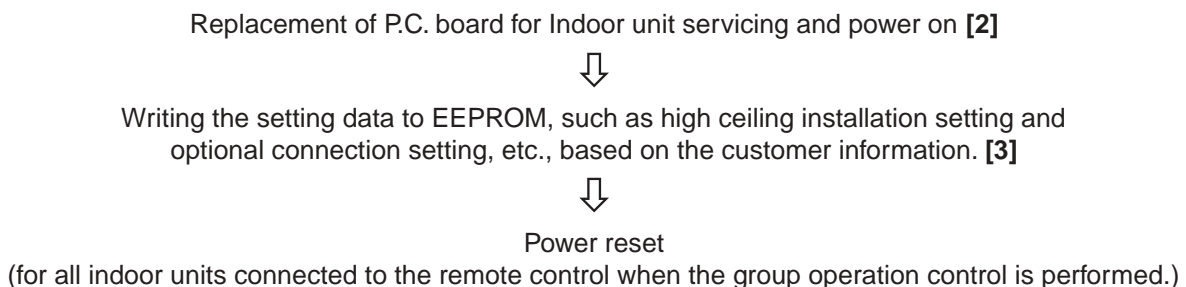

[1] Setting data read out from EEPROM

The setting data modified on the site, other than factory-set value, stored in the EEPROM shall be read out.

<RBC-ASCU11-*>

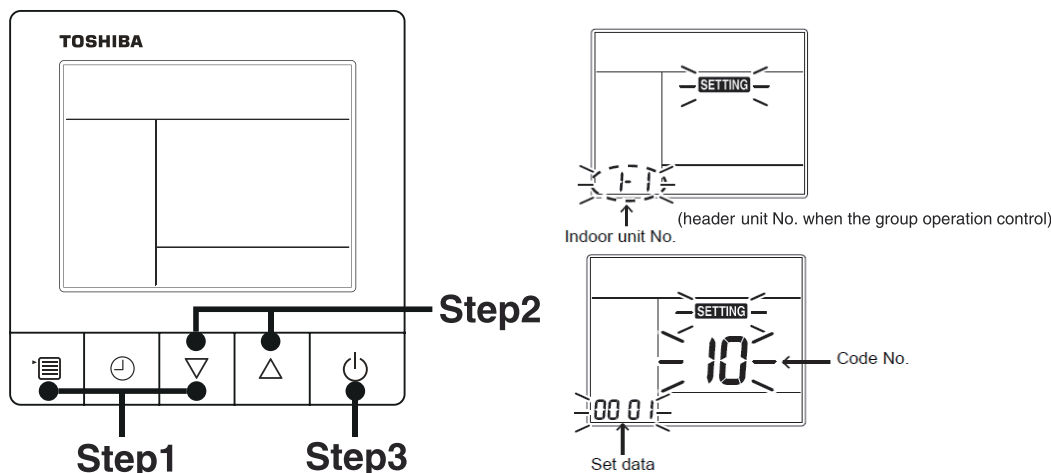

Step 1 Push and hold the [menu + ▽] buttons at same time for more than 10 seconds.

*When the group operation control is performed, the unit No. displayed for the first time is the header unit No.

At this time, the Code No. (DN) shows "10". Also, the fan of the indoor unit selected starts its operation and the swing operation also starts if it has the louvers.

Step 2 Every time when the [▽ or △] button is pushed, the indoor unit No. under the group control is displayed in order. Specify the indoor unit No. to be replaced.

1. Change the Code No. (DN) to 10 → 01 by pushing [▽ or △] buttons setting. (this is the setting for the filter sign lighting time.)

At this time, be sure to write down the setting data displayed.

2. Change the Code No. (DN) by pushing [▽ or △] buttons. Similarly, be sure to write down the setting data displayed.

3. Repeat the step 2-2 to set the other settings in the same way and write down the setting data as shown in the table 1 (example).

* The Code No. (DN) are ranged from "01" to "FE". The Code No. (DN) may skip.

<RBC-AMT***>

[1] Setting data read out from EEPROM

The setting data modified on the site, other than factory-set value, stored in the EEPROM shall be read out.

Step 1 Push SET , ON and TEST button on the remote controller simultaneously for more than 4 seconds.

*When the group operation control is performed, the unit No. displayed for the first time is the header unit No.

At this time, the CODE No. (DN) shows "10". Also, the fan of the indoor unit selected starts its operation and the swing operation also starts if it has the louvers.

Step 2 Every time when the UNIT LOUVER (left side button) button is pushed, the indoor unit No. under the group control is displayed in order. Specify the indoor unit No. to be replaced.

1. Change the CODE No. (DN) to 10 → 01 by pushing DOWN / UP buttons for the temperature setting. (this is the setting for the filter sign lighting time.)

At this time, be sure to write down the setting data displayed.

2. Change the CODE No. (DN) by pushing DOWN / UP buttons for the temperature setting. Similarly, be sure to write down the setting data displayed.

3. Repeat the step 2-2 to set the other settings in the same way and write down the setting data as shown in the table 1 (example).

* The CODE No. (DN) are ranged from "01" to "FE". The CODE No. (DN) may skip.

CODE No. required at least

DN	Contents
10	Type
11	Indoor unit capacity
12	System address
13	Indoor unit address
14	Group address
5d	External static pressure
FC	Communication protocol

1. The Code No. for the Indoor unit type and Indoor unit capacity are required to set the rotation number setting of the fan.
2. If the system/indoor/group addresses are different from those before replacement, the auto-address setting mode starts and the manual resetting may be required again.
(when the multiple units group operation including twin system.)

[2] P.C. Board for indoor unit servicing replacement procedures

Step 1 Replace the P.C. board to the P.C. board for indoor unit servicing.

At this time, perform the same setting of the jumper wire (J01, J08, J09) setting (cut), switch SW501, (short-circuit) connector CN34 as the setting of the P.C. board before replacement.

Models	MMD-UP***1SPHY**
CN34's status before replacement	The CN34 connector is mounted on the PC board, connected with a floating switch connector
When replacement, the corresponding method of CN34 on the replacement of PC board	Insert the the floating switch connector into CN34 on the replacement of PC board, and don't use the attached short circuit connector

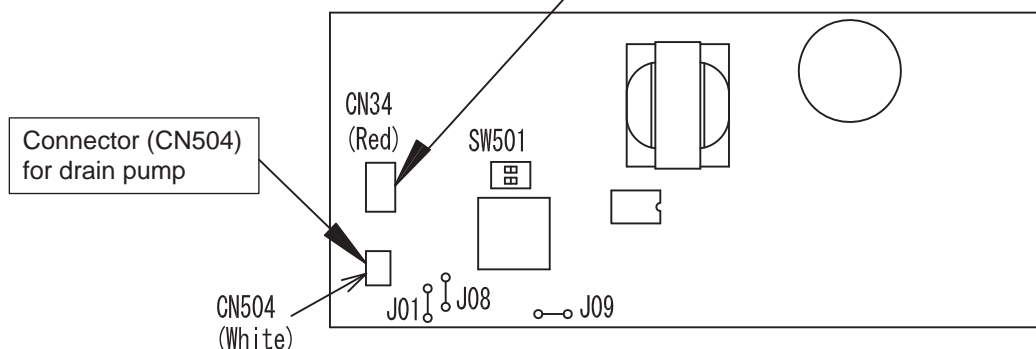

Step 2 It is necessary to set indoor unit to be exchanged: Remote controller = 1 : 1

Based upon the system configuration, turn on power of the indoor unit with one of the following items.

- 1) Single (Individual) operation. Turn on power of the indoor units and proceed to [3].
- 2) Group operation
 - A) In case that power of the exchanged indoor unit only can be turned on
Turn on power of the exchanger indoor unit only and proceed to [3].
 - B) In case that power of the indoor units cannot be turned on individually (**Case 1**)
 - a) Remove temporarily the group wire connected to the terminal blocks A and B of the exchanged indoor unit.
 - b) After connecting the remote controller wire only to the removed terminal block, turn on power of the indoor units and proceed to [3].
* When the above methods cannot be used, follow to the two cases below.
 - C) In case that power of the indoor units cannot be turned in individually (**Case 2**)
 - a) Remove all CN41 connectors of the indoor units in the same group except those of the exchanged indoor unit.
 - b) Turn on power of the indoor units and proceed to [3].
* After [3] operation has finished, be sure to return the temporarily removed group wire or CN41 connector to the original connection.

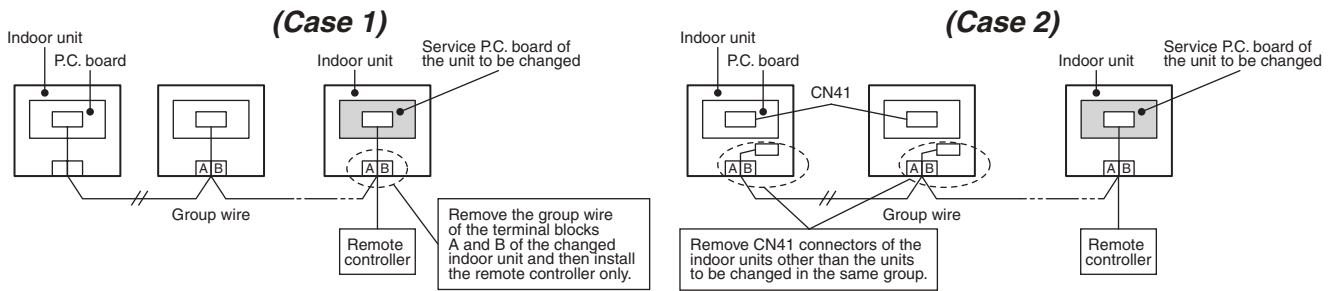

[3] Writing the setting data to EEPROM

The settings stored in the EEPROM of the P.C. board for indoor unit servicing are the factory-set values.

<RBC-ASCU11-*>

Step 1 Push and hold the [menu + ▽] buttons at same time for more than 10 seconds.

* When the group operation control is performed, the unit No. displayed for the first time is the header unit No.

At this time, the Code No. (DN) shows "10". Also, the fan of the indoor unit selected starts its operation and the swing operation also starts if it has the louvers.

Step 2 Every time when the [▽ or △] button is pushed, the indoor unit No. in the group control operation are displayed in order.

(The settings stored in the EEPROM of the P.C. board for indoor unit servicing are the factory-set values.)

Specify the indoor unit No. with its P.C. board replaced to the P.C. board for indoor unit servicing. (You cannot perform this operation if "ALL" is displayed.)

Step 3 Select the Code No. (DN) can be selected by pushing the [▽ or △] button.

- Set the indoor unit type and capacity.

The factory-set values shall be written to the EEPROM by changing the type and capacity.

1. Push the [menu] button to make Code No. flash. And set the Code No. (DN) to 10 .
2. Push the [menu] button to make SET DATA flash. And select the type by pushing the [•□ or •⊕] buttons.
(For example, 4-way Cassette Type is set to "0001". Refer to table 2)
3. Push [OFF timer] button.
(The changed data is set.)
4. Change the Code No. (DN) to "11" by pushing the [▽ or △] buttons.
5. Select the capacity by pushing the [▽ or △] buttons.
(For example, UP009 Type is set to "0003". Refer to table 3)
6. Push [OFF timer] button.
(The changed data is set.)

Step 4 Write the on-site setting data to the EEPROM, such as address setting, etc. Perform the steps 1 and 2 above again.

Step 5 Change the Code No. (DN) to "01" by pushing the [▽ or △] buttons.
(this is the setting for the filter sign lighting time.)

Step 6 Check the setting data displayed at this time with the setting data put down in [1].

1. If the setting data is different, modify the setting data by pushing the [▽ or △] buttons to the data put down in [1].
2. If the data is the same, proceed to next step.

Step 7 Change the Code No. (DN) by pushing the [▽ or △] buttons.

As described above, check the setting data and modify to the data put down in [1].

Step 8 Repeat the steps 6 and 7.

Step 9 After the setting completes, push the [ON/OFF] button to return to the normal stop status.
(It takes approx. 1 min until the remote controller operation is available again.)

<RBC-AMT***>

Step 1 Push , and buttons on the remote controller simultaneously for more than 4 seconds.

* In the group control operation, the unit No. displayed for the first time is the header unit No..
At this time, the CODE No. (DN) shows “ ”. Also, the fan of the indoor unit selected starts its operation and the swing operation starts if it has the louvers.
(The unit No. “ ” is displayed if the auto-address setting mode is interrupted in [2] step 2 a))

Step 2 Every time when (left side button) button is pushed, the indoor unit No. in the group control operation are displayed in order.
(The settings stored in the EEPROM of the P.C. board for indoor unit servicing are the factory-set values.)

Specify the indoor unit No. with its P.C. board replaced to the P.C. board for indoor unit servicing.
(You cannot perform this operation if “ ” is displayed.)

Step 3 Select the CODE No. (DN) can be selected by pushing the / button for the temperature setting.

• Set the indoor unit type and capacity.
The factory-set values shall be written to the EEPROM by changing the type and capacity.

1. Set the CODE No. (DN) to . (without change)
2. Select the type by pushing / buttons for the timer setting.
(For example, 4-way Cassette Type is set to “ ”. Refer to table 2)
3. Push button.
(The operation completes if the setting data is displayed.)
4. Change the CODE No. (DN) to “ ” by pushing / buttons for the temperature setting.
5. Select the capacity by pushing / buttons for the timer setting.
(For example, UP018 Type is set to “ ”. Refer to table 3)
6. Push button.
(The setting completes if the setting data are displayed.)

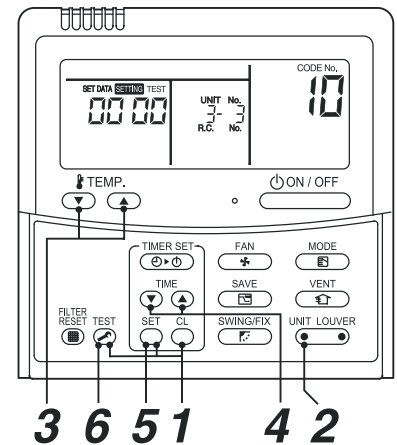

Step 4 Write the on-site setting data to the EEPROM, such as address setting, etc. Perform the steps 1 and 2 above again.

Step 5 Change the CODE No. (DN) to “ ” by pushing / buttons for the temperature setting.
(this is the setting for the filter sign lighting time.)

Step 6 Check the setting data displayed at this time with the setting data put down in [1].

1. If the setting data is different, modify the setting data by pushing / buttons for the timer setting to the data put down in [1].
The operation completes if the setting data is displayed.
2. If the data is the same, proceed to next step.

Step 7 Change the CODE No. (DN) by pushing / buttons for the temperature setting.
As described above, check the setting data and modify to the data put down in [1].

Step 8 Repeat the steps 6 and 7.

Step 9 After the setting completes, push button to return to the normal stop status.
(It takes approx. 1 min until the remote controller operation is available again.)

* The CODE No. (DN) are ranged from “ ” to “ ”. The CODE No. (DN) is not limited to be serial No.
Even after modifying the data wrongly and pushing button, it is possible to return to the data before modification by pushing button if the CODE No. (DN) is not changed.

Table 1. Setting data (CODE No. table (example))

DN	Item	Factory-set value
01	Filter sign lighting time	Depending on Type
02	Filter pollution level	0000: standard
03	Central control address	00Un/0099: Unfixed
06	Heating suction temperature shift	Depending on model type
0F	Cooling only	0000: Heat pump
10	Type	Depending on model type
11	Indoor unit capacity	Depending on capacity type
12	System address	00Un/0099: Unfixed
13	Indoor unit address	00Un/0099: Unfixed
14	Group address	00Un/0099: Unfixed
19	Louver type (wind direction adjustment)	Depending on Type.
1E	Temperature range of cooling/heating automatic SW control point	0003: 3°C (Ts±1.5°C)
28	Power failure automatic recovery	0000: None
2b	Thermo output SW (T10 ③)	0000: Thermo ON
31	Ventilation fan (standalone)	0000: Not available
32	Sensor SW	0000: Body sensor
5d	External static pressure	0000: Standard
60	Timer setting (wired remote controller)	0000: Available
d0	Remote controller operation save function	0001: Able
E0	Destination SW	0004: Global
F6	Presence of Application control kit	0000: None

Table 2. Type: CODE No. 10

Setting data	Type	Model name
0015	Slim duct	MMD-UP***1SPHY*

Table 3. Indoor unit capacity: CODE No. 11

Setup data	Model
0000*	Invalid
0044	003 type
0041	005 type
0001	007 type
0003	009 type
0005	012 type
0007	015 type
0009	018 type
0011	024 type
0012	027 type

12. DETACHMENTS

⚠ WARNING

Be sure to stop operation of the air conditioner before work and then turn off switch of the breaker.

⚠ CAUTION

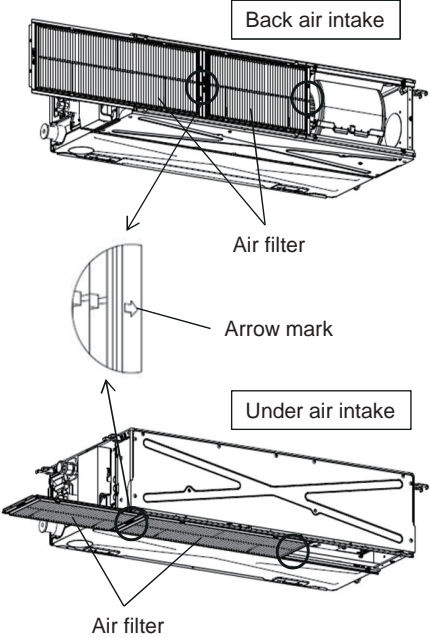
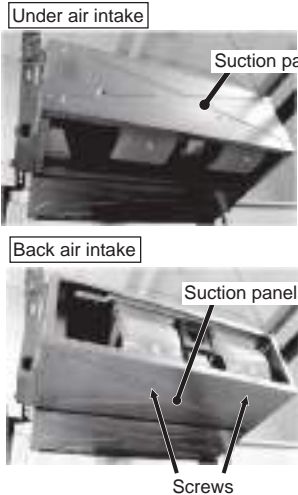

Be sure to put on gloves during working time; otherwise an injury will be caused by a part etc.

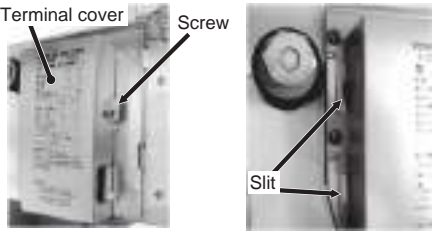
No.	Part name	Procedure	Remarks
①	Air filter	<p>1. Detachment</p> <p>1) Slide the filter toward the opposite side of the arrow mark and then pull out the filter. (Pull out the first filter, then the second filter will be pulled out connected with the first filter.)</p> <p>2. Attachment</p> <p>1) Insert the filter in the filter rail toward the arrow mark, slide it until the filter stops and then fix it. (Insert the second filter in the same direction after inserting the first filter.)</p>	
②	Suction panel	<p>1. Detachment</p> <p>1) Holding the suction panel with your hand, remove the screws fixing the panel in place. (UP003~012: M4×10 7 pcs) (UP015~027: M4×10 9 pcs)</p> <p>NOTE)</p> <ul style="list-style-type: none"> • Be careful that the suction panel doesn't fall while at work. • For the back air intake, remove the screws (2 locations) used to fix the fan case (lower) in place as well. <p>2. Attachment</p> <p>1) While holding the suction panel with your hand so that the panel does not fall off, tighten the screws that you removed in step 1-1) of "② Suction panel."</p>	

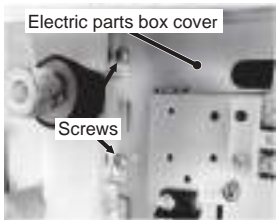
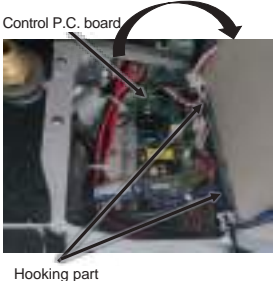
No.	Part name	Procedure	Remarks
③	Terminal cover	<p>1. Detachment</p> <p>1) Slightly loosen the screw holding the terminal cover in place. (M4×10 1 pcs)</p> <p>2) Lifting the terminal cover upward, pull the right side of the cover toward you and then disengage the claws on the left side of the cover from their slits to detach the terminal cover.</p> <p>2. Attachment</p> <p>1) Insert the claws on the left side of the terminal cover into their slits.</p> <p>2) Moving the terminal cover downward, insert the cover in the gap between the terminal box and screw that you loosened in step 1-1) of “③Terminal cover” and tighten the screw to fix the cover in place.</p>	

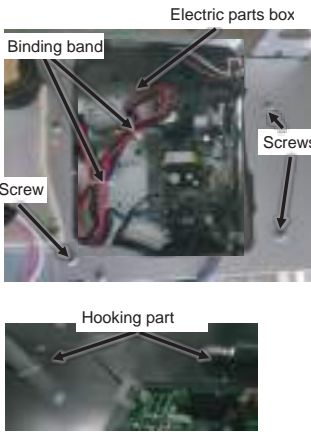

No.	Part name	Procedure	Remarks
④	Electric parts box cover	<p>1. Detachment</p> <p>1) Perform step 1 of “③Terminal cover” as required. (You may be able to perform this procedure without removing the electric parts box cover.)</p> <p>2) Slightly loosen the screw holding the electric parts box cover in place. (M4×10 2 pcs)</p> <p>3) Lifting the electric parts box cover upward, pull the left side of the cover toward you to open it.</p> <p>NOTE) If it is difficult to open the electric parts box cover because of the power supply and communication cables connected to the cover, disconnect these cables and perform the procedure.</p> <p>4) Disconnect the following connectors from the control P.C. board.</p> <p>NOTE) Unlock the lock of the housing to disconnect the connectors. CN40 ...Indoor/Outdoor communication (2P: Blue) CN41 ...Remote control connector (2P: Blue) CN67 ...Power supply connector (5P/3P: Black)</p> <p>5) Lift the electric parts box cover upward and pull the cover to the left toward you to detach it from the claws on the right side.</p> <p>2. Attachment</p> <p>1) Insert the hooking plates of the main body into the hook holes on the right side of the electric parts box cover.</p> <p>2) Reconnect the cables that you disconnected in step 1-4) of “④Electric parts box cover.”</p> <p>3) Moving the electric parts box cover downward, close the electric parts box cover. Insert the cover in the gap between the box and screws that you loosened in step 1-2) of “④Electric parts box cover” and use the screws to fix the cover into place.</p>	 

No.	Part name	Procedure	Remarks
⑤	Electric parts box	<p>1. Detachment</p> <ol style="list-style-type: none"> 1) For the back air intake, perform the procedure in 1 of “②Suction panel.” 2) Perform the procedure in 1 of “④Electric parts box cover.” 3) Remove the binding bands and clamps inside the electric parts box. 4) Remove the screws that fix the electric parts box into place. (M4×10 3 pcs) The electric parts box will not fall off even when the screws are removed. 5) Move the electric parts box in the direction opposite to the air blow-off port side to disengage the hooking plates and then remove the electric parts box from the under air intake side. <p>2. Attachment</p> <ol style="list-style-type: none"> 1) Insert the hooking plates of the electric parts box into the hooking parts of the main body. 2) Carefully restore the electric parts box to its original state without getting the cables caught by the box. Fix the box using the screws that you removed in step 1-4) of “⑤Electric parts box.” <p>NOTE) Make sure that the hooking plates are securely inserted into the hooking parts of the electric parts box. (Hooking plates: 2 locations)</p> <p>NOTE) Make sure to securely fix the clamps and binding bands of the cables that you disconnected.</p>	 <p>The top photograph shows the electric parts box with several components labeled: 'Binding band' (pointing to a red band), 'Screw' (pointing to a screw on the left), and 'Screws' (pointing to screws on the right). The box is labeled 'Electric parts box' at the top. The bottom photograph shows a close-up of the 'Hooking part' of the box, with two arrows pointing to the hooking plates.</p>

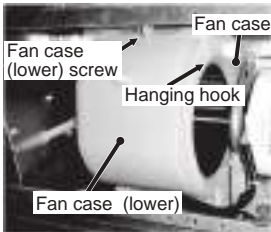
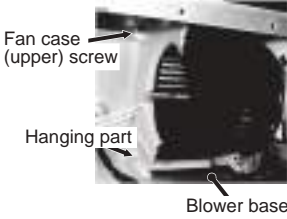
No.	Part name	Procedure	Remarks
⑥	Control P.C. board	<p>1. Detachment</p> <p>1) Perform the procedure in 1 of “④Electric parts box cover.”</p> <p>2) Disconnect the connectors from other components from the control P.C. board.</p> <p>NOTE) Unlock the lock of the housing to disconnect the connectors.</p> <p>CN40 ...Indoor/Outdoor communication terminal block (2P: Blue)</p> <p>CN41 ...Remote control connector (2P: Blue)</p> <p>CN67 ...Power supply connector (5P/3P: Black)</p> <p>CN100 ...TC1 sensor (2P: Brown)</p> <p>CN101 ...TC2 sensor (2P: Black)</p> <p>CN102 ...TCJ sensor (2P: Red)</p> <p>CN104 ...TA sensor (2P: Yellow)</p> <p>CN210 ...Fan motor power supply (7P: White)</p> <p>CN82 ...PMV lead (6P: Blue)</p> <p>NOTE) The following two connectors are connected only to the control P.C. board of a model equipped with a drain pump.</p> <p>CN34 ...Float switch (3P: Red)</p> <p>CN504 ...Drain pump lead (2P: White)</p> <p>3) Unlock the card edge spacers (4 locations) to remove the control P.C. board.</p> <p>2. Attachment</p> <p>1) Attach the control P.C. board to the clamps.</p> <p>2) Reconnect the cables that you disconnected in step 1-2) of “⑥Control P.C. board.”</p> <p>NOTE) Check there is no missing or contact failure on the connectors.</p>	<p>Control P.C.</p>  <p>If it is difficult to disconnect the bottom connector, first remove the card edge spacers (2 locations at bottom), and then proceed.</p> <p>Card edge spacer</p> 

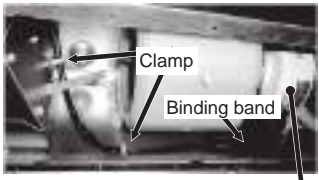
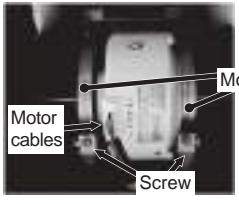
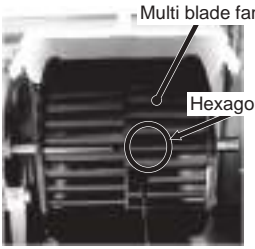
No.	Part name	Procedure	Remarks
⑦	Fan case (lower), Fan case (upper)	<p>1. Detachment</p> <ol style="list-style-type: none"> 1) For the back air intake, perform the procedure in 1 of “②Suction panel.” 2) Remove the screw on the rear of the fan case (lower). (One M4×10 screw for each fan case) 3) Disengage the hanging hooks on both sides of the fan case (lower) to remove the fan case (lower). 4) Remove the screws used to attach the fan case (upper). (Two M4×10 left and right screws for each fan case) 5) Move the hooking plate of the fan case (upper), which is hooked to the blower base, downward to remove the fan case (upper). <p>2. Attachment</p> <ol style="list-style-type: none"> 1) Use the hooking plate to hook the fan case (upper) to the blower base to attach the fan case (upper). <p>NOTE) Make sure the fan case (upper) does not move even if you pull on it.</p> <ol style="list-style-type: none"> 2) Use the screws that you removed in step 1-4) of “⑦Fan case (lower/upper)” to attach the fan case (upper). 3) Insert the tip of the fan case (lower) into the blower base and use the hooking plate to attach the fan case. 4) Use the screws that you removed in step 1-2) of “⑦Fan case (lower/upper)” to attach the fan case (upper). 	 

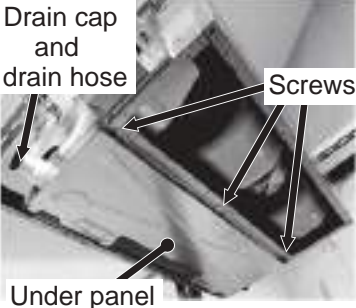
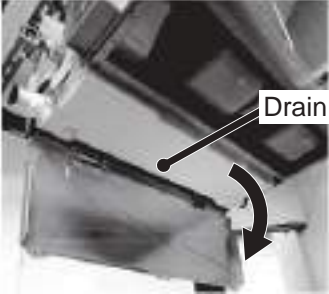
No.	Part name	Procedure	Remarks
⑧	Fan motor, Multi blade fan	<p>1. Detachment</p> <p>1) For the back air intake, perform the procedure in 1 of “②Suction panel.”</p> <p>2) Perform the procedure in steps 1-1), 1-2), 1-3) of “④Electric parts box cover.”</p> <p>3) Disconnect the following connector of the control P.C. board.</p> <p>NOTE) Unlock the lock of the housing to disconnect the connectors. CN210 ...Fan motor power supply (5P: White)</p> <p>4) Detach the clamps and binding bands of the cable.</p> <p>5) Perform the procedure in steps 1-2), 1-3) of “⑦Fan case (lower/upper).”</p> <p>6) Remove the screws of the motor bands. (M5×10 2 pcs) The motor band will not fall off even when the screws are removed.</p> <p>7) Hold the motor bands with your hand so that they do not fall off, and remove the bands.</p> <p>8) Loosen the hexagonal hole screw of the multi blade fan and remove the fan from the shaft.</p> <p>2. Attachment</p> <p>1) Insert the fan motor shaft into the multi blade fan, and secure it loosely. With the shaft still loosely secured, assemble the fan motor, and secure it using the motor band.</p> <p>NOTE) When assembling the fan motor, ensure that the motors cables are positioned on the left side facing the drain pan, and assemble the motor so that the motor cables are pointing straight down.</p> <p>2) Align the position of the multi blade fan so that it is positioned at the center of the fan case (upper) and fix the fan using the hexagonal hole screw.</p> <p>NOTE) Arrange the multi blade fan so that screws position at the right side against the drain pan.</p> <p>NOTE) Fix multi blade fan with torque wrench 4.9 N•m or more.</p> <p>3) Perform the procedure in steps 2-3) and 2-4) of “⑦Fan case (lower/upper)” to attach the fan case (lower).</p> <p>4) Reconnect the cables that you disconnected in steps 1-3) and 1-4) of “⑧Fan motor, Multi blade fan”.</p> <p>NOTE) Check there is no missing or poor contact of the connectors. Finally check whether the multi blade fan turns surely and smoothly or not.</p>	   <p>(Drain pan side)</p>

No.	Part name	Procedure	Remarks
⑨	Under panel, Drain pan	<p>1. Detachment</p> <p>1) Take off the drain cap and drain the drain water accumulated in the drain pan. In case of natural drain model, drain the drain water by taking off hose band and drain hose.</p> <p>NOTE) When taking off drain cap and drain hose, be sure receive drain water in a bucket, etc.</p> <p>2) Slightly loosen the screw holding the under panel in place. (M4x10 3pcs)</p> <p>3) Move the under panel toward the air intake side to hang the panel.</p> <p>4) Pull out the drain pan.</p> <p>NOTE)</p> <ul style="list-style-type: none"> • When pulling out the drain pan, never pull out the drain socket by drawing it with hands. If doing so, water leak may be caused. • When pulling out the drain pan, some drain water may still be left in the pan so be absolutely sure to discard this water. <p>5) After pulling out the drain pan slightly, pull it out again toward the air intake side to detach the pan.</p> <p>2. Attachment</p> <p>1) Hook the drain pan to the flange portion of the air intake side to attach the pan, and then push it in.</p> <p>2) Hook the under panel on the screws that you untightened in step 1-2) of “⑨Under panel, Drain pan” and tighten these screws.</p> <p>3) Attach the drain cap and drain hose that you removed in step 1-1) of “⑨Under panel, Drain pan.” When you attach the drain cap and drain hose, be sure to insert them firmly into the base of the drain socket of the drain pan.</p> <p>NOTE) Finally, be sure to check there is no water leakage from each attached part.</p>	  

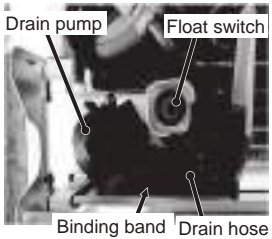
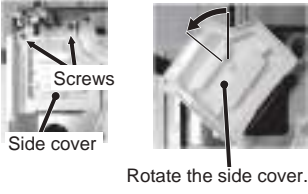
No.	Part name	Procedure	Remarks
⑩	Drain pump, Float switch, Drain hose *For only drain pump incorporated model	<p>1. Detachment</p> <p>1) Perform the procedure in steps 1-1), 1-2), 1-3) of “④Electric parts box cover” and 1 of “⑨Under panel, Drain pan.”</p> <p>2) Disconnect the following connectors and connected cables from the control P.C. board.</p> <p>NOTE) Unlock the lock of the housing to disconnect the connectors. CN34 ...Float switch (3P: Red) CN504 ...Drain pump lead (2P: White)</p> <p>3) Detach the binding bands to disconnect the drain hose.</p> <p>4) Detach the binding bands that bundle the drain pump and float switch cables and pull in the cables from the control P.C. board.</p> <p>5) Remove the screws that fix the side cover. (M4×10 2 pcs)</p> <p>6) Detach the side cover from the side plate and then rotate the cover. Next, pull out the drain pump and other drain pump kit components from the side. (The drain pump and other drain pump kit components are fixed to the side cover.)</p> <p>NOTE)</p> <ul style="list-style-type: none"> • If the pipes are damaged, refrigerant leak may be caused. Take out them with great care. • One of two methods can be used: Either pull out the drain pump from the side or remove the screws (3 locations) used to fix the drain pump in place from the bottom side, and take out the drain pump from the bottom side. • Please be careful to avoid damage to the foam part caused by the screws of drain pump kit. <p>2. Attachment</p> <p>1) Carefully insert the side cover (which fixes the drain pump and other drain pump kit components removed in step 1-5) of “⑩Drain pump, Float switch, Drain hose”) from the side, so that you do not damage the pipes. Then fix the side cover using the screws.</p> <p>2) Insert the drain hose into the port of the drain pump and fix the hose using the binding bands.</p> <p>3) Reconnect the cables and then perform the procedure in 2 of “⑨Under panel, Drain pan.”</p> <p>NOTE) Finally check whether they correctly operate or not.</p>	 <p>Drain pump Float switch Binding band Drain hose</p>  <p>Rotate. Rotate the side cover.</p> <p>Screws Side cover</p>

No.	Part name	Procedure	Remarks
⑪	Heat exchanger	<p>1. Detachment</p> <p>1) Recover refrigerant, and then remove refrigerant pipes at indoor unit side.</p> <p>2) Perform the procedure in steps 1-1), 1-2), 1-3) of “④Electric parts box cover” and 1 of “⑨Under panel, Drain pan.”</p> <p>3) Disconnect the following connector of the control P.C. board.</p> <p>NOTE) Unlock the lock of the housing to disconnect the connectors. CN82 ...PMV (6P: White)</p> <p>4) Remove the TC1, TC2, and TCJ sensors from the heat exchanger, and then detach the binding bands used for fixing cables, such as the sensor cables, PMV cable, and drain pump cable.</p> <p>5) Remove the screws of the pipe cover. Next lift up the pipe cover and disengage the cover from the hooking parts to remove it. (M4×10 2 pcs)</p> <p>6) Remove the screws of the side cover to which the drain pump is attached, and slightly pull out the side cover. (M4×10 2 pcs)</p> <p>7) Remove the screws of the heat exchanger fixed plate (U pipe side), which are used for fixing the end plate of heat exchanger. (M4×10 2 pcs)</p> <p>8) Remove the screws of the heat exchanger fixed plate (pipe side) and detach the plate (pipe side). (M4×10 3 pcs)</p> <p>NOTE)</p> <ul style="list-style-type: none"> • One screw (1 location) is concealed by the drain pump. Shift the drain pump slightly in order to remove the screw. • If it is difficult to remove the screws on the U pipe side, remove the under panel. • When removing the top side screw on the U pipe side, use a longish screwdriver as necessary. Also, when removing the upper side screw, use a shortish screwdriver. <p>9) Detach the heat exchanger.</p> <p>2. Attachment</p> <p>1) Restore the components and cables to their original conditions and fix them in the following order: Sensors → Heat exchanger → Heat exchanger fixed plate (pipe side) → Heat exchanger fixed plate (Use the screws to fix the plate to the U pipe side.) → Pipe cover → Side cover → Drain pump → Under panel</p> <p>2) Connect the refrigerant pipe as before, and then perform vacuuming.</p>	<p>The 'Remarks' column contains seven sequential photographs with labels: 1) 'Sensors' and 'Binding band' pointing to components on the heat exchanger. 2) 'Pipe cover', 'Hooking part', and 'Screws' pointing to the cover being removed. 3) 'Heat exchanger', 'Heat exchanger fixed plate (pipe side)', and 'Heat exchanger fixed plate (U pipe side)' pointing to the main unit and its mounting plates. 4) 'Heat exchanger fixed plate (pipe side) screws' pointing to screws being removed from the pipe side. 5) 'Move the drain pump slightly.' pointing to the drain pump being shifted. 6) 'Top side screw' and 'Under side screw' pointing to screws on the U pipe side. 7) 'Locations of screws as viewed from the air outlet side' and 'Heat exchanger fixed plate (U pipe side) screws' pointing to the final screw locations.</p>

13. EXPLODED VIEWS AND PARTS LIST

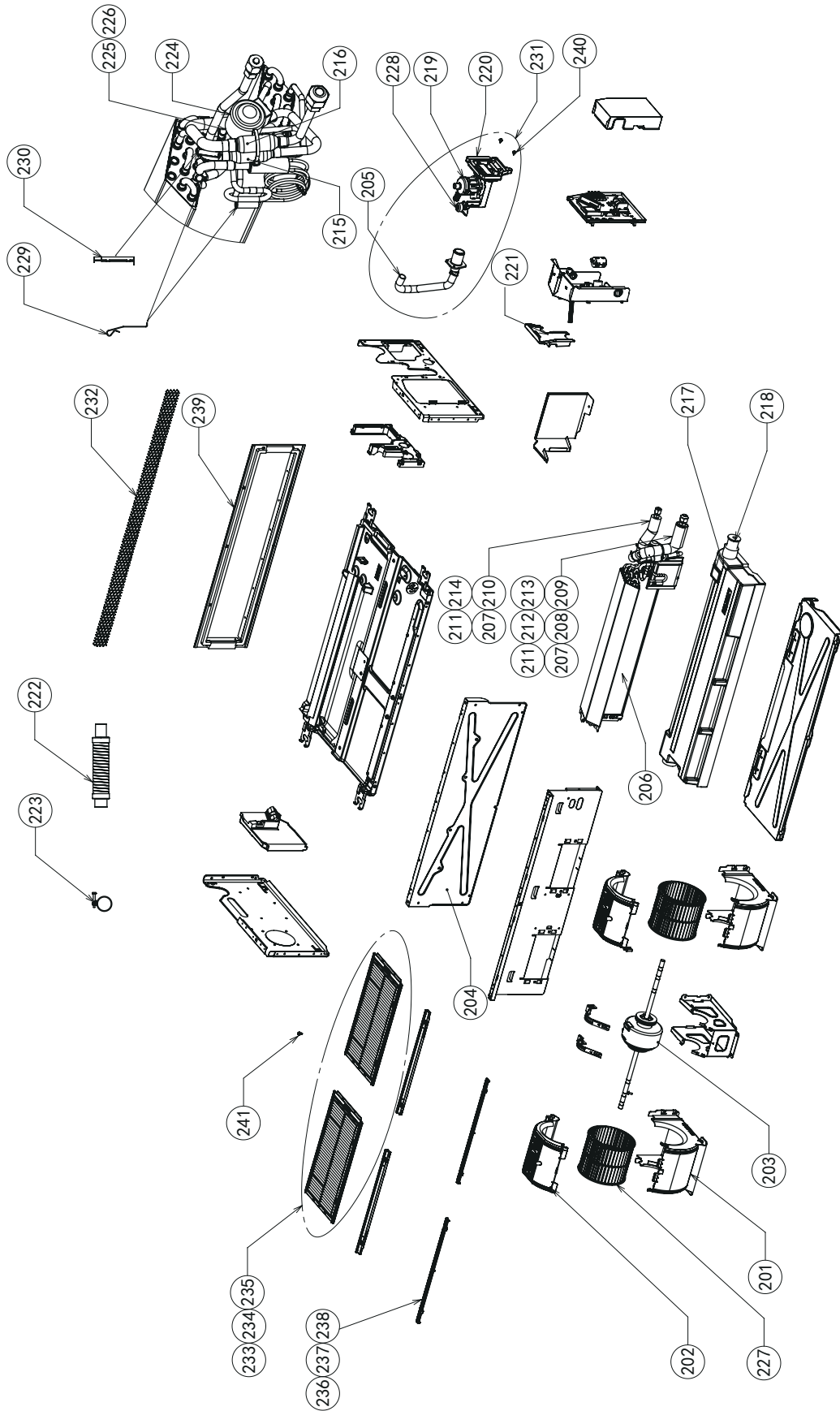

Location No.	Part No.	Description	Q'ty/Set MMD-UP***1SPHY-E/TR								
			003	005	007	009	012	015	018	024	027
201	43H22003	CASE,FAN,UPPER	2	2	2	2	2				
	43H22004	CASE,FAN,UPPER						2	2		
	43H22005	CASE,FAN,UPPER								2	2
202	43H22006	CASE,FAN,LOWER	2	2	2	2	2				
	43H22007	CASE,FAN,LOWER						2	2		
	43H22008	CASE,FAN,LOWER								2	2
203	43H21004	MOTOR,FAN						1	1	1	1
	43H21011	MOTOR,FAN	1	1	1	1	1				
204	43H00021	PLATE,INLET	1	1	1	1	1				
	43H00022	PLATE,INLET						1	1		
	43H00023	PLATE,INLET								1	1
205	43H70001	HOSE,DRAIN	1	1	1	1	1	1	1	1	1
206	43H44028	REFRIGERATION CYCLE ASSY	1	1							
	43H44029	REFRIGERATION CYCLE ASSY			1	1	1				
	43H44031	REFRIGERATION CYCLE ASSY						1	1		
	43H44032	REFRIGERATION CYCLE ASSY								1	1
207	43H49003	SOCKET	1	1	1	1	1			1	1
208	43H49004	SOCKET						1	1		
209	43H49005	SOCKET								1	1
210	43H49006	SOCKET	1	1	1	1	1	1	1		
211	43H49007	NUT,FLARE	1	1	1	1	1			1	1
212	43H49008	NUT,FLARE						1	1		
213	43H49009	NUT,FLARE								1	1
214	43H49010	NUT,FLARE	1	1	1	1	1	1	1		
215	43H47006	STRAINER	1	1	1	1	1	1	1	1	1
216	43H47007	STRAINER	1	1	1	1	1				
217	43H72001	PAN ASSY,DRAIN	1	1	1	1	1				
	43H72002	PAN ASSY,DRAIN						1	1		
	43H72003	PAN ASSY,DRAIN								1	1
218	43H79001	CAP,DRAIN	1	1	1	1	1	1	1	1	1
219	43H77001	PUMP,DRAIN	1	1	1	1	1	1	1	1	1
220	43H19006	COVER ASSY,SIDE	1	1	1	1	1	1	1	1	1
221	43H19007	COVER,PIPE	1	1	1	1	1	1	1	1	1
222	43H70002	HOSE,DRAIN	1	1	1	1	1	1	1	1	1
223	43H79002	BAND,HOSE	1	1	1	1	1	1	1	1	1
224	43H46069	COIL,PMV	1	1	1	1	1	1	1	1	1
225	43H46065	BODY,PMV	1	1	1	1	1				
226	43H46068	BODY,PMV						1	1	1	1
227	43H20006	FAN,MULTI BLADE	2	2	2	2	2				
	43H20007	FAN,MULTI BLADE						2	2		
	43H20008	FAN,MULTI BLADE								2	2
228	43H51002	SWITCH,FLOAT	1	1	1	1	1	1	1	1	1
229	43H47008	HOLDER,SENSOR(TC)	2	2	2	2	2	2	2	2	2
230	43H47009	HOLDER,SENSOR(TC1)	1	1	1	1	1	1	1	1	1
231	43H77002	PUMP,DRAIN ASSY	1	1	1	1	1	1	1	1	1
232	43H39005	EVAPORATOR, WIND								1	1

Location No.	Part No.	Description	Q'ty/Set MMD-UP***1SPHY-E/TR								
			003	005	007	009	012	015	018	024	027
233	43H80030	AIR FILTER	1	1	1	1	1				
234	43H80036	AIR FILTER						1	1		
235	43H80037	AIR FILTER								1	1
236	43H80038	RAIL,FILTER	1	1	1	1	1				
237	43H80039	RAIL,FILTER						1	1		
238	43H80040	RAIL,FILTER								1	1
239	43H00024	FLANGE,OUTLET	1	1	1	1	1				
	43H00025	FLANGE,OUTLET						1	1		
	43H00026	FLANGE,OUTLET								1	1
240	43H97007	SCREW	1	1	1	1	1	1	1	1	1
241	43H97008	SCREW	1	1	1	1	1	1	1	1	1

Electric Parts

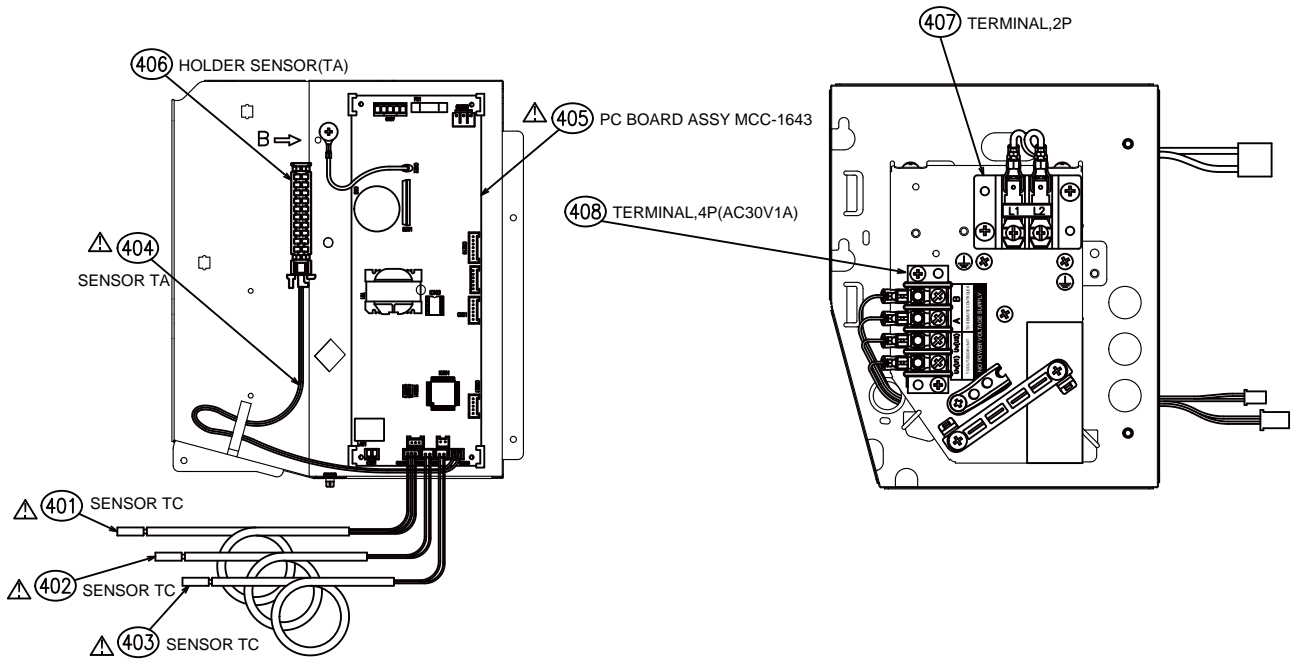

Location No.	Part No.	Description	MMD-UP***1SPHY-E/TR								
			003	005	007	009	012	015	018	024	027
401	43H50009	SENSOR, TC	1	1	1	1	1	1	1	1	1
402	43H50010	SENSOR, TC	1	1	1	1	1	1	1	1	1
403	43H50011	SENSOR, TC	1	1	1	1	1	1	1	1	1
404	43H50012	SENSOR, TA	1	1	1	1	1	1	1	1	1
405	43H69082	PC BOARD ASSY, MCC-1643	1	1	1	1	1	1	1	1	1
406	43H63001	HOLDER, SENSOR(TA)	1	1	1	1	1	1	1	1	1
407	43H60007	TERMINAL, 2P	1	1	1	1	1	1	1	1	1
408	43H60004	TERMINAL, 4P(AC30V1A)	1	1	1	1	1	1	1	1	1

WARNINGS ON REFRIGERANT LEAKAGE

Check of Concentration Limit

The room in which the air conditioner is to be installed requires a design that in the event of refrigerant gas leaking out, its concentration will not exceed a set limit. The refrigerant R410A which is used in the air conditioner is safe, without the toxicity or combustibility of ammonia, and is not restricted by laws to be imposed which protect the ozone layer. However, since it contains more than air, it poses the risk of suffocation if its concentration should rise excessively. Suffocation from leakage of R410A is almost non-existent. With the recent increase in the number of high concentration buildings, however, the installation of multi air conditioner systems is on the increase because of the need for effective use of floor space, individual control, energy conservation by curtailing heat and carrying power etc. Most importantly, the multi air conditioner system is able to replenish a large amount of refrigerant compared with conventional individual air conditioners. If a single unit of the multi conditioner system is to be installed in a small room, select a suitable model and installation procedure so that if the refrigerant accidentally leaks out, its concentration does not reach the limit (and in the event of an emergency, measures can be made before injury can occur). In a room where the concentration may exceed the limit, create an opening with adjacent rooms, or install mechanical ventilation combined with a gas leak detection device. The concentration is as given below.

$$\frac{\text{Total amount of refrigerant (kg)}}{\text{Min. volume of the indoor unit installed room (m}^3\text{)}} \leq \text{Concentration limit (kg/m}^3\text{)}$$

Refrigerant Concentration Limit shall be in accordance with local regulations.

NOTE 1 :

If there are 2 or more refrigerating systems in a single refrigerating device, the amounts of refrigerant should be as charged in each independent device.

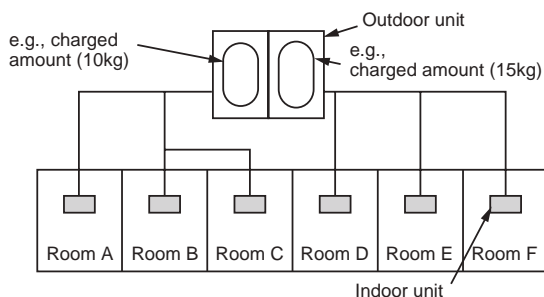

For the amount of charge in this example:

- The possible amount of leaked refrigerant gas in rooms A, B and C is 10kg.
- The possible amount of leaked refrigerant gas in rooms D, E and F is 15kg.

Important

NOTE 2 :

The standards for minimum room volume are as follows.

- (1) No partition (shaded portion)

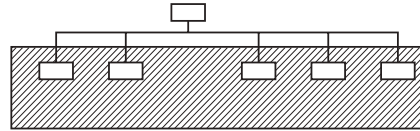

- (2) When there is an effective opening with the adjacent room for ventilation of leaking refrigerant gas (opening without a door, or an opening 0.15% or larger than the respective floor spaces at the top or bottom of the door).

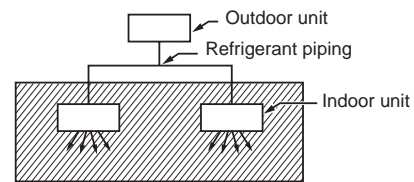

- (3) If an indoor unit is installed in each partitioned room and the refrigerant piping is interconnected, the smallest room of course becomes the object. But when a mechanical ventilation is installed interlocked with a gas leakage detector in the smallest room where the density limit is exceeded, the volume of the next smallest room becomes the object.

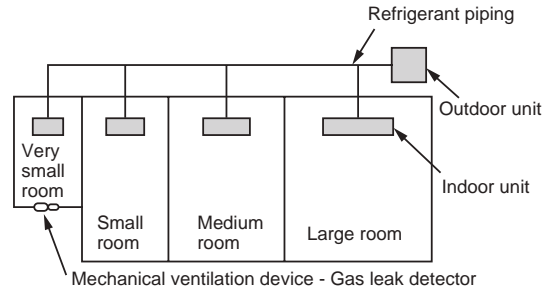

Toshiba Carrier Air Conditioning (China) Co., Ltd.